



**Benefitbee**<sup>®</sup>

LOVE THE BEES, BENEFIT THE WORLD



2024.1  
CATALOG



# PRODUCT CATALOG

CHINA PROFESSIONAL BEEKEEPING SOLUTION PROVIDER

Shenzhen Benefitbee Bee Industry Co.,LTD  
zhongshan Benefitbee Beekeeping Equipment Co.,LTD



## Shenzhen Benefitbee Bee Industry Co.,Ltd

深圳市益蜂蜂业有限公司, 成立于2009年, 是中国养蜂学会理事单位, 中国蜂机具专业委员会常务委员单位, 广东省养蜂学会副理事长单位, 中国畜牧业协会蜂业分会副会长单位, 深圳潮汕商会常务理事单位, 深圳网贸会副会长单位。

Established in 2009, Shenzhen Benefitbee Bee Industry Co., LTD is standing corporate member of China Beekeeping Equipment Committee, council member of Guangdong Apiculture Association, Vice President Unit of CAAA(China Animal Agriculture Association) Apiculture Branch, Council Unit of Shenzhen Chaoshan Commerce Chamber, Vice President Unit of Shenzhen E-commerce Association.

目前经营1100多种养蜂机具, 拥有40多项发明、实用新型和外观等专利, 每年上百种养蜂机具新品研发, 年出口额名列行业前茅, 旗下Benefitbee品牌系列蜂机具在国际上有很高的知名度, 公司常年为国内外同行设计、研发、生产、供应各种新型养蜂机具。

We are managing more than 1100 types of beekeeping equipment. Practical and appearance patents, our equipment with Benefitbee brand are enjoying highly reputation in international market. Throughout years, we design, develop, produce and supply new style equipment for peer company home and abroad.



是一家集设计、开发、生产与出口销售各种养蜂装备的一站式专业制造商, As a professional manufacturer Integrating designing, development, production and sales.



DESIGNING



DEVELOPMENT



PRODUCTION



SALES



With more than 40 inventions

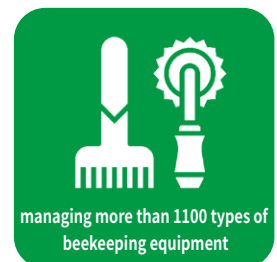

managing more than 1100 types of beekeeping equipment





## Subsidiary factory

旗下五金塑料工厂——中山市益蜂蜂机有限公司, 拥有中国发达的工业制造技术与产业配套优势, 目前拥有一整套完善的模具开发与生产设备, 年产各种养蜂刀具200多万把, 金属隔王板50多万片, 喷烟器20多万个, 塑料巢础200多万片, 塑料隔王板100多万片, 塑料巢框50多万个, 拥有塑料和五金蜂机具模具400余副。

**Affiliated to Benefitbee, zhongshan Benefitbee Beekeeping Equipment Co.,LTD** With China advanced manufacturing technology and supporting advantages, zhongshan Benefitbee' s annual production capacity reaches:

>2,000,000 hive tools

>2,000,000 plastic foundations

>500,000 metal queen excluders

>1,000,000 plastic queen excluders

>200,000 bee smokers

>500,000 plastic frames

Until now, we have produced more than 400 sets of plastic and hardware tooling.

旗下蜂箱工厂——黄山市益蜂蜂箱有限公司, 位于美丽的安徽省黄山市, 拥有优势的木材原材料资源以及先进的生产设备, 工厂占地20亩, 年产蜂箱10万套, 巢框200万个, 木制隔王板50多万片, 进出口资质齐全, 常年为澳大利亚、新西兰、美国、韩国等国家生产和出口高质量的蜂箱产品。

**Shenzhen Benefitbee, Huangshan Benefitbee Beehive Co., LTD** is located in a pretty city called Huangshan, in Anhui Province, owning advantageous raw material sources and advanced production equipment. Huangshan Benefitbee occupies an area of 1.5 hectares, annually produces 100,000 beehives, 2 million frames, more than 500,000 wooden queen excluders. Anhui Benefitbee is a qualified exporter supplying high quality beehives to Australia, New Zealand, USA and Korea.

公司自创立以来, 充分发扬自主创新的精神, 凭借多年来的蜂机具出口与制造经验、珠三角得天独厚的交通便利, 秉着“关爱蜜蜂、造福人类”的企业使命, “巧夺天工, 精益求精”的质量方针, “一言九鼎、无微不至”的经营理念, 不断提升在品种、质量、价格以及服务上的综合竞争优势, 赢得世界众多知名企业的认可并且建立了战略合作伙伴关系, 产品远销全球140多个养蜂强国及地区。

Since establishment, Benefitbee has been carrying strong spirit of self innovation, relying on extensive experiences and unique transportation networks, we are making continuous progress in becoming more competitive in product range/ quality/price/Service. Holding the mission of “Love the bees, Benefit the world”, with the philosophy of “Keeping a solemn promise, granting the best care”, we have won the recognition from many famous beekeeping enterprises and established strategic partnership with them. Benefitbee products have been sold to more than 140 countries and areas with powerful apiculture.

企业的成功来源于高品质的产品、优质的服务以及客户的信赖。我们真诚期望与世界蜂业界朋友们建立友好长久的合作关系, 为中国乃至世界养蜂业的快速发展而携手并进!

Business success results from high quality product, excellent service and customers' trust. We sincerely expect to build long term partnership with friends from apiculture industry. Let' s work shoulder to shoulder, hand in hand, to make contribution to rapid development of world' s apiculture!





# We are different



## D1 Variety

Shenzhen Benefitbee Bee Industry Co., Ltd( FengQingWanZhong Bee Industry Limited) operates more than 800 beekeeping tools currently, 40% of which are self-produced. We invest hundreds of thousands of dollars for mold; research & develop dozens of new products every year. We are the veritable one-stop beekeeping equipment supplier in China. The non-stop innovation ability determines our competitive advantage in the industry, but we believe that our advantage is not only the 800 products, but also the solution provide capacity of demand plan for the beekeeping tools and machine.



## D2 Quality

We refuse to exchange low quality for low price. The quality stability and functional practicability of our products are the necessary standards for measuring our products. The continuous upgrading and improvement of our products is the direction of our work. With more than ten years of experience in research & development, production and sales of beekeeping tools, we strictly control the products quality for our customers. Not all beekeeping tools can enter our catalogue. We promise that the products will be refunded in full if they have quality problems.



## D3 Price

40% of the varieties are self-produced and sold, first-hand sources. Although 60% are outsourced products, but our huge annual purchase volume determines our position, delivery, price, and quality standards with partners. The same quality with lower price, the same price with higher quality is our commitment to customers. Under the same conditions and the same price, if you find that the price is higher, we promise to refund the price difference.



## D4 Service

The prosperous Shenzhen Special Economic Zone will inevitably have high labor costs, but it provides us with a high-quality service team. 100% customer satisfaction is our pursuit, you will get our convenient, time-saving, money-saving and reassuring service during pre-sale, in-sale and after-sales! Your appeal is the source of our growth! If you have any service issues, welcome to direct complaint to the general manager's email: [elvis@benefitbee.com](mailto:elvis@benefitbee.com)



## D5 Transportation

Shenzhen Benefitbee Bee Industry Co., Ltd(FengQingWanZhong Bee Industry Limited) is headquartered in the Shenzhen Special Economic Zone, adjacent to Yantian Port, which is the largest port in China, also near to ports such as Shekou, Nansha and Huangpu. We can provide you with fast, convenient and cost-effective transportation solutions.



## D6 Industry

Our factory is located in the industrial city of China's Pearl River Delta. It has China's advanced production technology and industrial supporting advantages, such as the world's knife city in Yangjiang and the plastic mold capital in Dongguan. Its top industrial level creates first-class product quality.



## D7 Experience

Since its establishment in 2009, our products have been exported to more than 130 countries and regions, and we have visited dozens of countries and regions in the field. We have deep knowledge of beekeeping habits, market demand and product standards in most countries and regions around the world. These valuable experiences have created our comprehensive service capabilities!



## D8 Scale

Our company currently has 2000 square meters of hardware products factory; 1,500 square meters of plastic products factory; 3000 square meters warehouse distribution center; goods value of nearly 1 million US dollars in stock; 1000 square meters office; 400 square meters comprehensive exhibition hall; total employees more than 120 people; more than 300 carefully selected suppliers with high quality supporting. We strive to build our comprehensive strength to protect your logistics supply.



## D9 Background

Shenzhen Benefitbee Bee Industry Co., Ltd ( FengQingWanZhong Bee Industry Limited) is the governing unit of Chinese Beekeeping Society; the standing corporate member of the Chinese Beekeeping Equipment Committee and the Council Member of Guangdong Apiculture Association. We have never stopped communicating and learning with industry experts and scholars, which provides a valuable source for our research & development capacity!





# catalog

*01-12* Beehives

*13-14* beehive parts

*15-17* Hive accessories

*18-21* Frames

*22* Comb foundation

*23-24* Economy wire tools

*25* Bundle tools

*26-30* Queen excluders

*31* Pollen traps

*32-34* Bee feeders

*35-43* Bee smokers

*44-47* Honey extractors

*48-51* Hive tools

*52-54* Uncapping knives

*55-56* Uncapping forks

*57-58* Frame grip tools

*59-61* Filter tools

*62-63* Cleaning tools

*64-65* Bee brush

*66-67* Bee gloves

*68-70* Bee suits

*71* Bee hats

*72-74* Queen cages

*75-77* Queen breed tools

*78-79* Other products

*80-81* Pest control tools

*82-83* Bee medicines

*84* Bee wax

*85* Bee fodder

*86-88* Honey tank

*89* Honey pail

*90* Honey gates

*91* Wax press

*92* Beeswax foundation roller

*93-94* Honey processing machines

*95-97* Candle silicone moulds

*98* Beeswax silicone moulds

*99* Beeswax candle

*100* Resin crafts

*101* Honey bottle

*102-103* Bee crafts

*104* Bee broochs

*105* Bee accessories

*106* Bee 3D pictures



# Beehives

Benefitbee®

## BB Plastic beehive

This 1-floor multifunctional plastic hive consists of top cover, top feeder, inner cover, deep box, excluder and bottom.

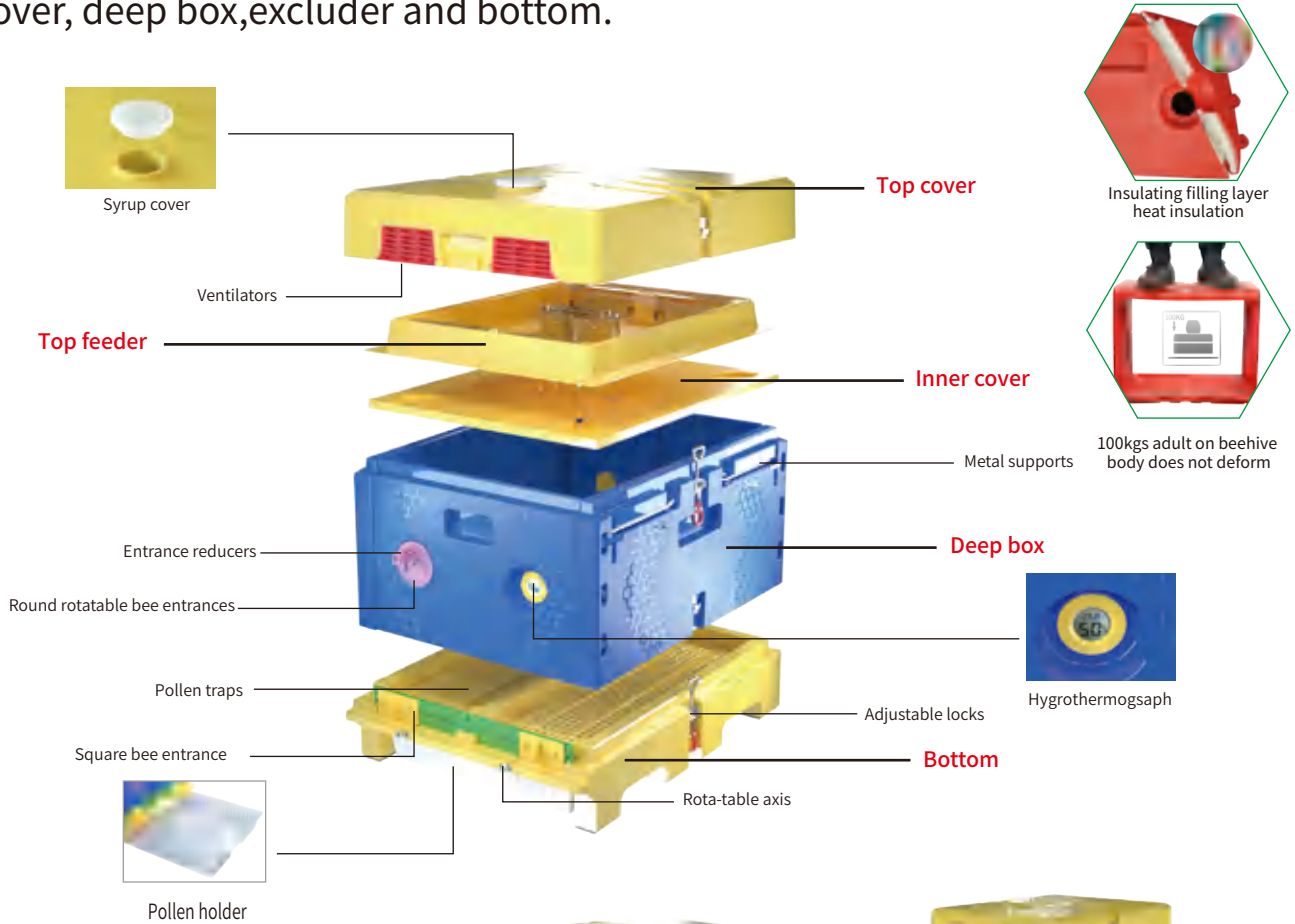

### Model: H21

455mm\*440mm\*576mm(1 LAYER)

- 1 Top cover
- 1 Top feeder
- 1 Inner cover
- 1 Deep box
- 1 Bottom

### Model: H21-2

700mm\*440mm\*576mm(2 LAYERS)

- 1 Top cover
- 1 Top feeder
- 1 Inner cover
- 2 Deep box
- 1 Excluder
- 1 Bottom

### Model: H21-3

945mm\*440mm\*576mm(3 LAYERS)

- 1 Top cover
- 1 Top feeder
- 1 Inner cover
- 3 Deep box
- 1 Excluder
- 1 Bottom





# Beehives

## BB Plastic beehive

Material: HDPE  
Standard Langstroth 10 frames

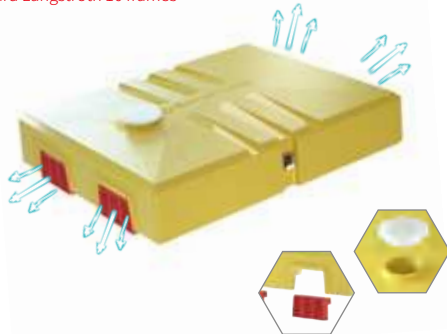

**Model:HP17**  
BB Beehive outer cover

Material: HDPE  
Standard Langstroth 10 frames

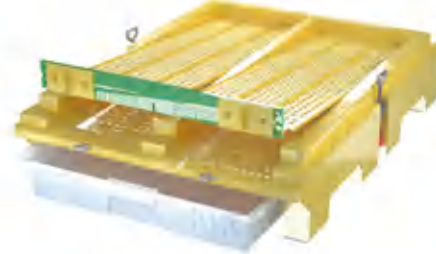

**Model:HP18**  
BB Bottom board

Material: PP  
Size:365\*40mm



**Model:HP19**  
BB Plastic slide beehive entrance

Material: PP  
Size:463x370x63mm  
Capacity: 8L



**Model:HP20**  
BB Pollen tray (8L)



(unassembled)

**Model:H21-4**  
BB Plastic beehive box  
Box inner size: 490x370x260mm  
suitable for length 490 and 483mm



### Deep box

There are grooves in the middle and at the two sides. While inserting PVC board or a wooden board, beekeeper can keep two queen bees.



# Beehives



## Model:H27L-P

### Langstroth Beehive

Approximate weight: 10.66kg  
 Material:EPS&plastic  
 Size:575.5\*440\*460mm  
 Foam density:150g

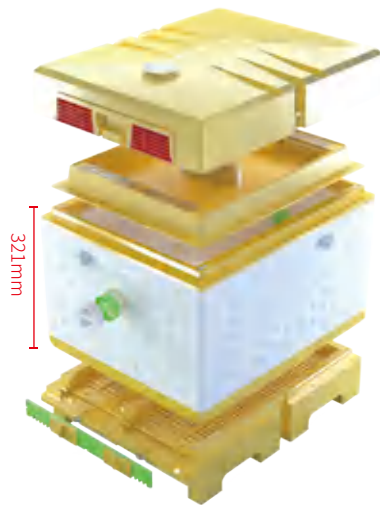
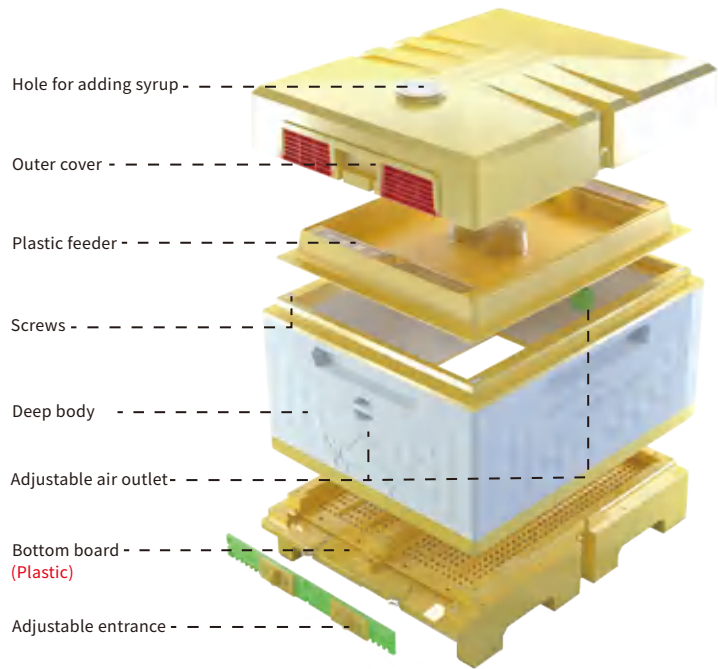

## Model:H27D-P

### EPS Dadant(US)Beehive

Approximate weight:11.2kg  
 Material:EPS&plastic  
 Size:575.5\*440\*513mm  
 Foam density:150g

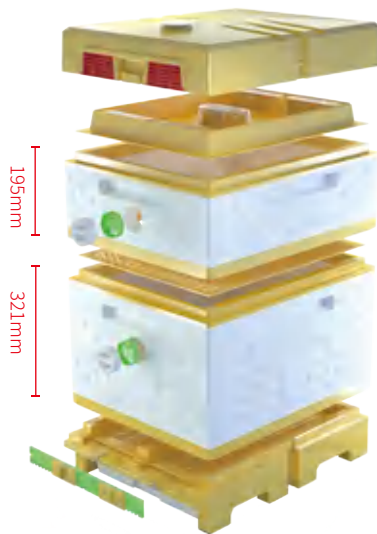

## Model:H27D-2P

### EPS Dadant(US)Beehive

Approximate weight:13.3kg  
 Material:EPS&plastic  
 Size: 575.5\*440\*688mm  
 Foam density:150g

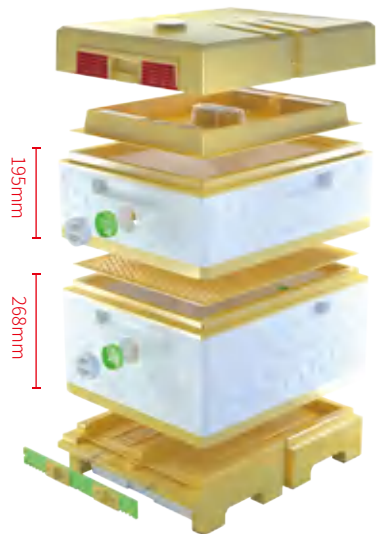

## Model:H27L-2P

### Langstroth Beehive

Approximate weight:13.3kg  
 Material:EPS&plastic  
 Size: 575.5\*440\*635mm  
 Foam density:150g

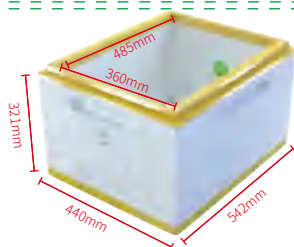

Langstroth 4/3 ( Jumbo,Dandant,)

## Model:H27-295

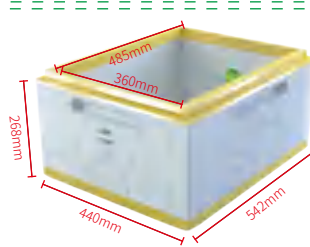

Langstroth 1/1

## Model:H27-245

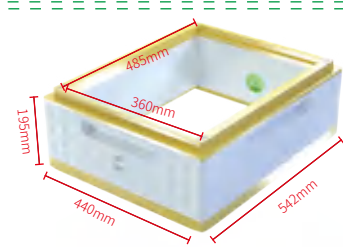

Langstroth 2/3

## Model:H27-168





# Beehives



## Model:H27L

### Langstroth Beehive

Approximate weight:8.81kg

Material:EPS&plastic

Size:575.5\*440\*456mm

Foam density:150g

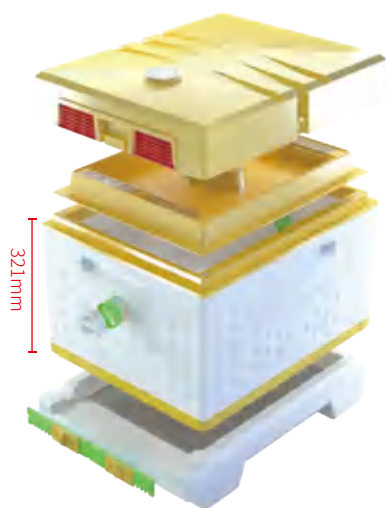
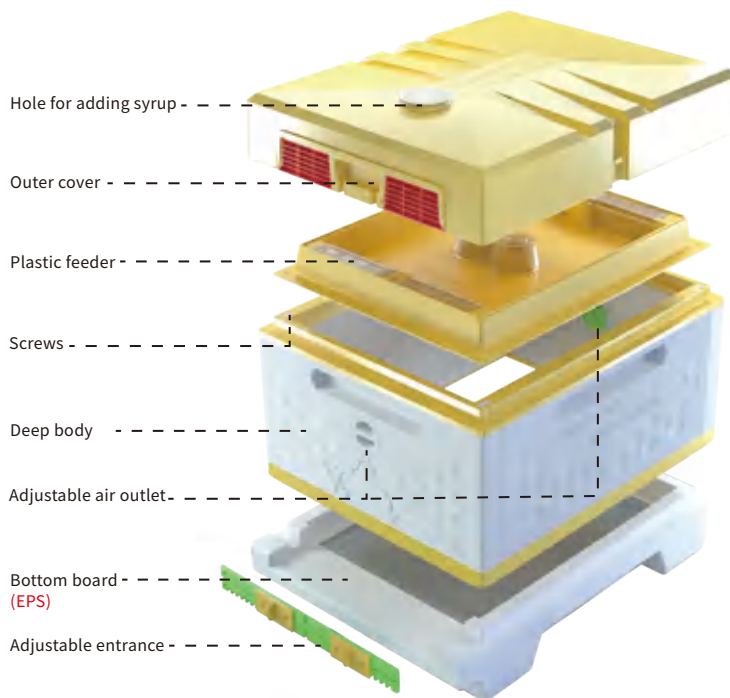

## Model:H27D

### EPS Dadant(US)Beehive

Approximate weight:9.35kg

Material:EPS&plastic

Size:575.5\*440\*509mm

Foam density:150g

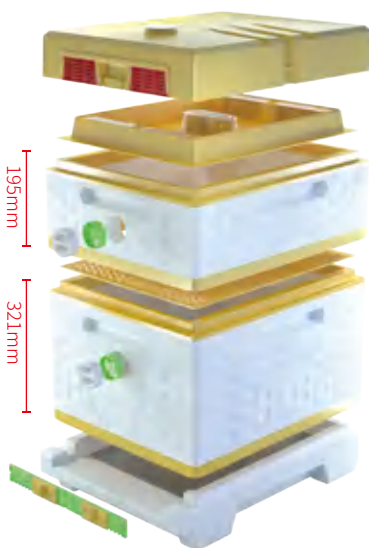

## Model:H27D-2

### EPS Dadant(US)Beehive

Approximate weight:12kg

Material:EPS&plastic

Size: 575.5\*440\*684mm

Foam density:150g

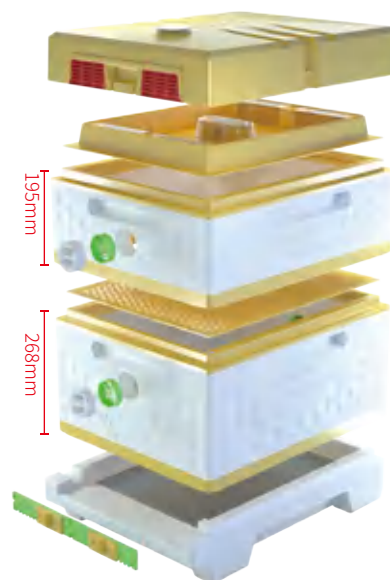

## Model:H27L-2

### Langstroth Beehive

Approximate weight:11.45kg

Material:EPS&plastic

Size:575.5\*440\* 631mm

Foam density:150g



# Beehives



## BB polystyrene beehive

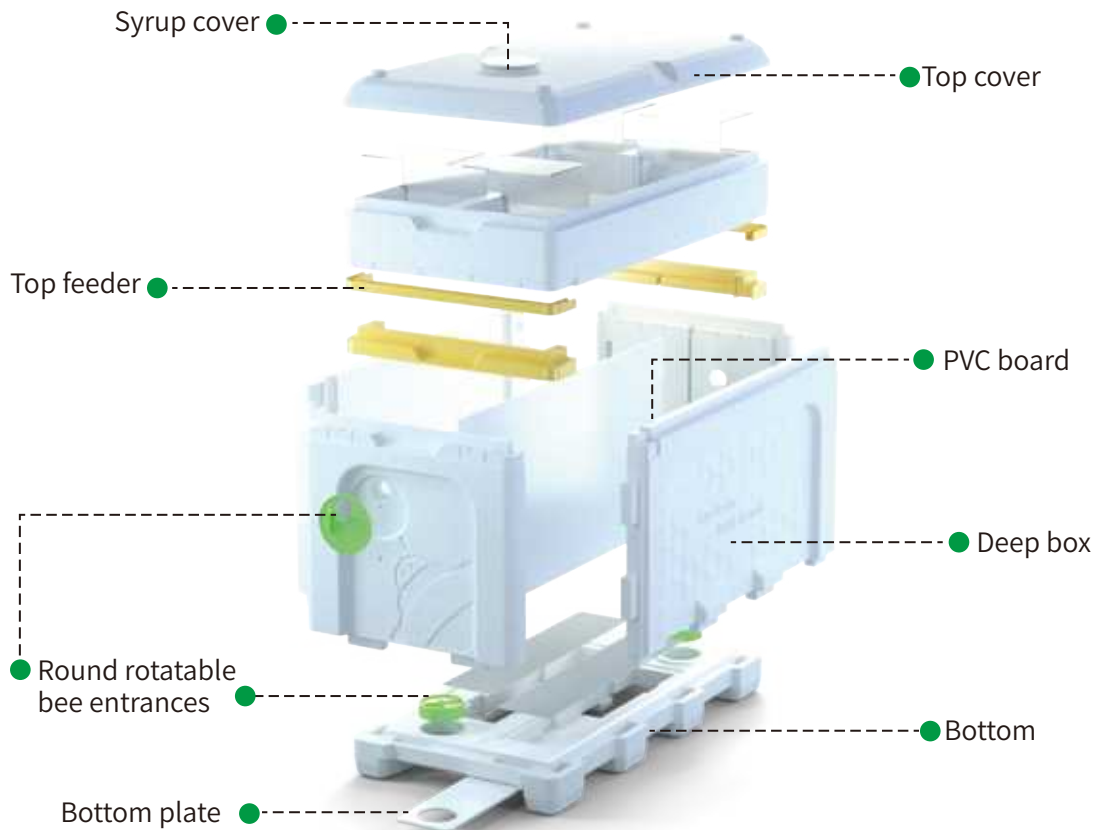

### Model : H10-7

### BB Queen mating box (6 frames)

Size: 530x285x408mm

Total weight: 3kg

Foam density: 120g

Material: EPS



① EPS material colors

Imported materials

② Painted colors

Surface spray



9 EPS material colors are available.





# Beehives



## BB Nuc box/Queen mating box

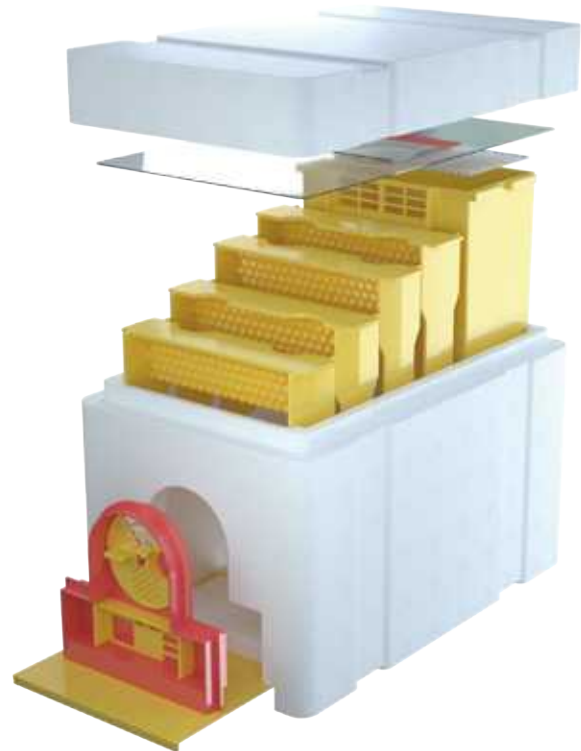
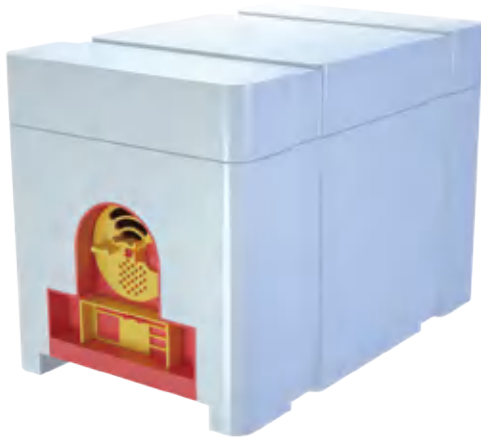

### Model: H10-2

Size: 24x15x17cm

Material: EPS

Standard: 4 frames

Patent No.: 2021 3 0233864. 9

1 plastic feeder, 1 floating net, 1 PVC transparent observation film, plastic hive door + breathable bottom board, foam density 120g.

## Queen mating box



### Model: H10-3



Lid -top cover

Transparent viewing panel

Net (Prevent bees from drowning)- Beefeeder

Beehive entrance

Frame

Deep hive body

Beehive entrance sheet-round sheet

Beehive entrance sheet-square sheet

Bottom board

Bottom plate

### Model: H10-3B

BB Plastic queen bee mating super box

Patent No.: 202130289413. 7

Material: HDPE

Size: 25.4x15.3x17.1cm

Standard: 4 frames

Optional Box color: blue, green, yellow



# Beehives



## BB Nuc box/Queen mating box

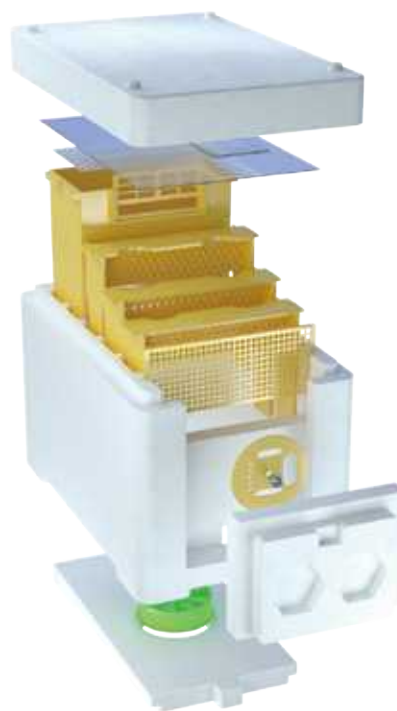

### Model: H10-4

Patent No.:2021 23305122.6

Size:24x15x17cm,  
material:EPS

Standard: 4 frames, 1 plastic feeder, 1 floating net, 1 PVC transparent observation film, plastic hive door + round plastic ventilators(5.5CM), foam density 120g.



### Model: H19

Size:LWH: 366\*197\*259mm

Material:PP



### Model: H19-2

Material: Tinplate size  
Diameter x height 10\*14cm

## Bee package

- 1.The Bee Cage have a good protective for Bees in the long-distance transportation.It' s suitable for mailing package and bee transfer place.
- 2.The Bee Cage' s up and down can be connected to each other, transport more firmly.
- 3.Large Capacity,ventilation de sign,foldable and assemble easily.

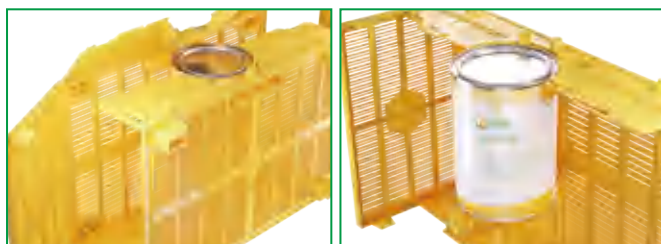



# Beehives

## Langstroth Beehive Kit



### Model: H22-2

#### Langstroth Beehive Kit

(2 deep box+1 super box)

Langstroth Beehive 10 Frames Standard

- 1 large iron cover
- 1 inner cover  
(marked with oval holes)
- 1 super box  
(505 \* 413 \* 168)mm
- 2 deep box  
(505 \* 413 \* 245)mm
- 1 bottom board
- 1 excluder  
(510x410)mm
- 20pcs wax sprayed black foundations  
(425x210)mm
- 10pcs wax sprayed yellow foundations  
(425x141)mm
- 10pcs first-class pine big frames  
(Pinus sylvestris without scab 483x232)mm
- 20pcs first-class pine small frames  
(Pinus sylvestris without scab 483x159)mm

### Material:

Chinese Fir with knot splicing board, the beehive is boiled twice with Paraffin, the first step is boiled for about 3.5 mins.



### Model: H22

#### Langstroth Beehive Kit

(1 deep box+1 super box)



### Model: H22-3

#### Langstroth Beehive Kit

(2 deep box+2 super box)



### Model: H22-4

#### Langstroth Beehive Kit

(1 deep box+4 super box)





# Beehives

Plus queen mating nuc box >>

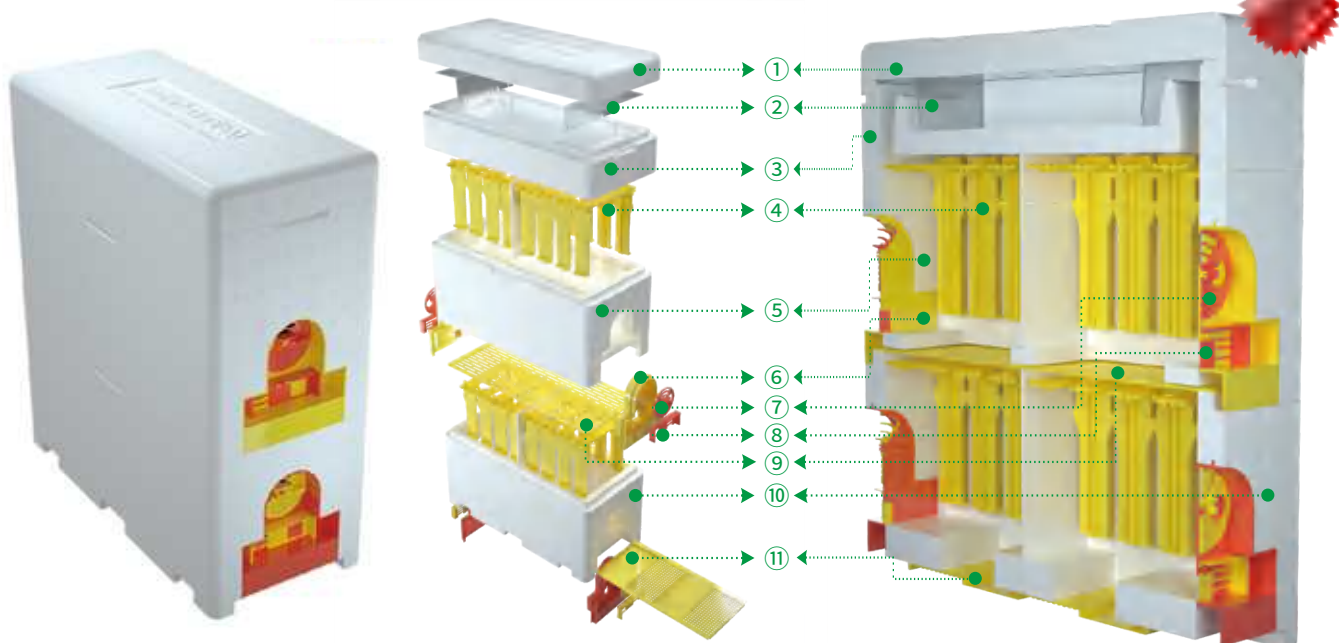

## Model: H18

Patented product

Patented no. 201910754536.5

Patented no. 201930438030.4

Patented no. 201921324972.0

- 1、 Lid –top cover
- 2、 Syrup excluder (one front and one back)
- 3、 Lid-bottom cover
- 4、 Frame (three of one group)
- 5、 Shallow super
- 6、 Beehive Entrance panel  
(Assembled with entrance sheet, three of one group)
- 7、 Beehive entrance sheet- round sheet  
(assemble with entrance panel, three of one group)

- 8、 Beehive entrance sheet- square sheet  
(assemble with entrance panel, three of one group)
- 9、 Queen excluder
- 10、 Deep hive body
- 11、 Bottom plate

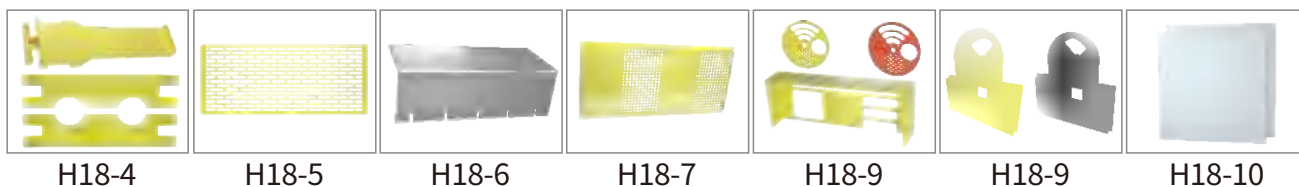

H18		Standard including : Lid, Feeder, Super box, Deep box Accessories: 16pcs plastic frame, 2pcs syrup excluder, 4pcs plastic entrance panel (red and yellow each 2pcs), 2pcs round entrance sheet, 2pcs square entrance sheet, 1pc bottom board, 1pc queen excluder, 2pcs PVC foam clapboard, Size:328mm*148mm*363mm
H18-2		Standard including : Lid, Feeder, Deep box Accessories: 8pcs plastic frame, 2pcs syrup excluder, 2pcs plastic entrance panel (red and yellow each 1pc), 1pcs round entrance sheet, 1pcs square entrance sheet, 1pc bottom board 1pc PVC foam clapboard, Size:328mm*148mm*230mm
H18-3		Standard including : Super box Accessories: 8pcs plastic frame, 2pcs syrup excluder, 2pcs plastic entrance panel (red and yellow each 1pc), 1pcs round entrance sheet, 1pcs square entrance sheet, 1pc bottom board, 1pc PVC foam clapboard, Size:328mm*148mm*143mm



## Model: H02(10 frame) H02-2(8 Frame)

Australian beehive

**Standard configuration(Australia beehive):**

- 1\*Outer cover(With metal)
- 1\*Deep hive body(L505\*W405/355\*H242\*20mm)
- 1\*Shallow super(L505\*W405/355\*H146\*20mm)
- 1\*Bottom board (With Entrance)

**Material:**

- New Zealand pine/Pinus sylvestris
- China fir (Unassemble)



## Model: H01(10frame) H01-2(8 Frame)

Langstroth beehive

**Standard configuration(Langstroth beehive):**

- 1\*Outer cover(With metal)
- 1\*Inner cover(L505\*W413/355mm)
- 1\*Deep hive body(L505\*W413/355\*H245\*20mm)
- 1\*Shallow super(L505\*W413/355\*H168\*20mm)
- 1\*Bottom board (With Entrance)

**Material:**

- New Zealand pine/Pinus sylvestris
- China fir (Unassemble)



# Beehives



Available material: China Fir, European Pine, China Pine and New Zealand Pine.  
Available size: 8 frame and 10 frame



**H02-2**  
Australia beehive  
(Waxed+ painted)



**H03**  
Italy beehive  
(2 Layers 10 frames)



**H04**  
Langstroth queen rearing  
box (4 or 5 frames)



**H04-2**  
5er Zander Ableger



**H06**  
Nuc bee box



**H06-2**  
Nuc bee box  
(Calcium plastic)



**H06-5**  
Nuc Mesh  
Transport Bag



**H07**  
Multifunctional  
plastic beehive



**H10-5**  
Queen mating box  
(120 g density)



**H10-6**  
Queen mating box  
(120 g density)



**H10**  
Queen bee mating box





# Beehives



Red cedar

H11  
UK style beehive



Red cedar

H12  
UK WBC beehive



H13  
Japan style beehive



H14  
Kenyan Hive



H17  
Observation hive



H26  
Kenya Set Beehive



H20  
Plastic beehive



(one bottom and two successors)

H24  
Ten-Frame Dadant Beehive



three floors

H25  
Ten-frame Zander beehive



H08  
Double layer  
plastic beehive



H09  
Insulated beehive



IH01  
Insect house



IH02  
Insect house



# Beehive parts



CNT:10PCS      New Zealand pine

(Langstroth\Australia  
\8\10frames can be chosen)  
Ventilated hole could be customized.

HP01

CNT:20PCS      New Zealand pine

(8frames\10frames can be chosen)

HP02

CNT:18PCS      ABS

355X 13 X 505mm(8 frame)  
405X 13 X 505mm(10 frame)  
Optional size in free term

HP02-3

CNT:20PCS      New Zealand pine  
(Splicing wood)

Board thickness:20mm

HP03

CNT:10PCS      New Zealand pine+  
Plywood

(8frames\10frames can be chosen)

HP04

CNT: 5PCS      New Zealand pine

(8frames\10frames can be chosen)

HP05

CNT:2PCS      New Zealand pine

(8frames\10frames can be chosen)

HP05-2

CNT: 5PCS      New Zealand pine  
(spray paint)

(8frames\10frames can be chosen)

HP05-3

CNT: 5PCS      PP

575\*420\*340mm  
(8frames\10frames can be chosen)

HP06/HP06-2

CNT:10PCS      Iron with spray paint

60X50X62CM(customizable)

HP06-3

CNT: 5PCS      Stainless steel 201

Size: customizable

HP06-4

CNT: 1PCS      Galvanized

Size: customizable

HP06-5



# Beehive parts

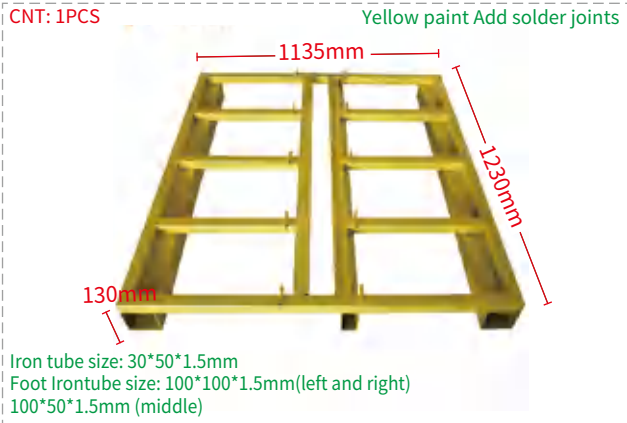

HP09

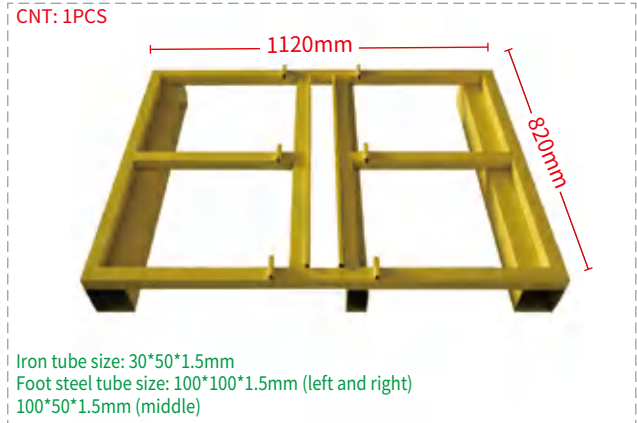

HP09-2



HP07



HP07-2

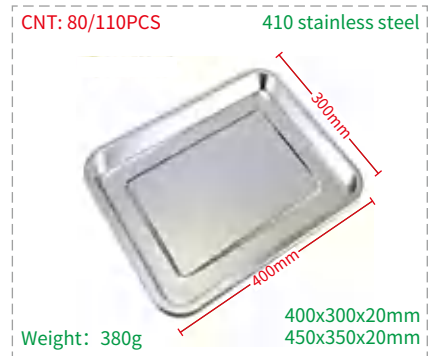

HP08/HP08-2



HP08-3/HP08-4/HP08-5



HP09-3



HP16/HP16-2



HP12 Risers



HP13 Cleats

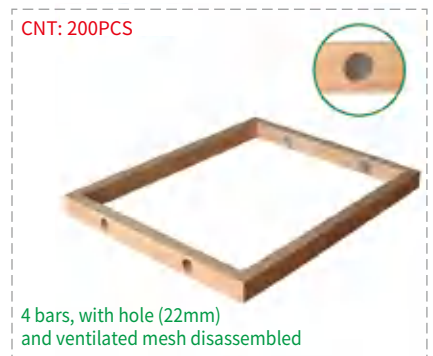

HP14 Rims





## Beehive entrance >>

<p>CTN:200PCS</p> <p>HA05</p>	<p>CTN:1000PCS</p> <p>SUS201 Size:50mm</p> <p>HA09-6B</p>	<p>CTN:2000PCS</p> <p>Size:50mm</p> <p>HA09-8</p>	<p>CTN:2000PCS</p> <p>Size:50mm</p> <p>HA09-9</p>	
<p>CTN:200PCS</p> <p>SUS201 Size:125mm</p> <p>HA09B</p>	<p>CTN:10000PCS</p> <p>Size:50mm</p> <p>HA09-3</p>	<p>CTN:2500PCS</p> <p>Plastic Size:68mm</p> <p>HA09-4</p>	<p>CTN:1200PCS</p> <p>Plastic Size:68mm</p> <p>HA09-5</p>	
<p>CTN:10000PCS</p> <p>PP Size:50mm</p> <p>HA09-6</p>	<p>CTN:1000PCS</p> <p>PP Size:125mm</p> <p>HA09-7</p>	<p>CTN:200PCS</p> <p>Size:125mm Galvanized iron</p> <p>HA09</p>	<p>CTN:1000PCS</p> <p>SUS201 Size:68mm</p> <p>HA09-2</p>	<p>Galvanized iron Size:369/312mm</p> <p>HA14-5</p>
<p>CTN:300PCS</p> <p>PP</p> <p>HA06</p>	<p>CTN:200PCS</p> <p>PP</p> <p>HA07</p>	<p>CTN:300PCS</p> <p>Plastic</p> <p>HA08</p>	<p>CTN:500PCS</p> <p>Iron</p> <p>HA01</p>	<p>CTN:200PCS</p> <p>Iron</p> <p>HA04-3</p>
<p>CTN:540PCS</p> <p>Iron</p> <p>HA02</p>	<p>CTN:300PCS</p> <p>Galvanized iron</p> <p>HA03</p>	<p>CTN:100PCS</p> <p>Iron plating</p> <p>HA04</p>	<p>CTN:300PCS</p> <p>Stainless steel</p> <p>HA04-B</p>	<p>CTN:50/70PCS</p> <p>Galvanized iron</p> <p>HA23/HA23-2</p>



# Hive accessories

## Frame support >>



HA34  
Frame support  
CTN:40PCS



HA34-2  
Frame support  
CTN:40PCS



HA34-3  
Frame support  
CTN:40PCS

## Escape >>



Model: HA25-2  
16 ways bee escape  
CTN:100PCS



CTN:100PCS

HA25



CTN:100PCS

HA26



CTN:200PCS

HA26-2



CTN:140PCS

HA27



CTN:2500PCS

HA28



CTN:450PCS

HA29



CTN:1600PCS

HA30



CTN:3000PCS

HA31



CTN:450PCS

HA24



CTN: 50LB Size:2-1/4 inch  
Size:1-1/4 inch

HA48/HA49

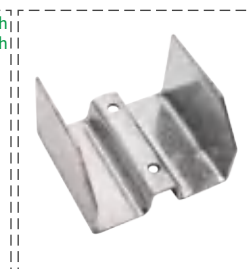

HA49-1



HA49-2

## Frame fixator >>



HA16  
(450x22mm)  
(10/11/12 frame)  
CTN:1000PCS



HA16-2  
(375x22mm)  
(8/9/10 frame)  
CTN:1000PCS



HA14  
(370x31mm)  
(10 frame)  
CTN:500PCS



HA14-2  
(370x21mm)  
(9 frame)  
CTN:1000PCS



HA14-3  
(375x21mm)  
(10 frame)  
CTN:1000PCS



HA14-4  
(450x21mm)  
(10 frame)  
CTN:1000PCS



HA15-1/2  
(450/375mm)  
CTN:1000PCS



## Connector & handle >>



CTN:200PCS

**HA21-2**  
Beehive connector



CTN:50PCS

**HA17**  
Spring fastener



CTN:50PCS

**HA17-2**  
Spring fastener



CTN:50PCS

**HA17-3**  
Spring fastener  
(line diameter 4mm)



CTN:200PCS

**HA21**  
Beehive connector  
improved type



CTN:600PCS

**HA20**  
Beehive angle  
clamp



CTN:150PCS

**HA22**  
Beehive handle



CTN:200PCS

**HA22-2**  
Beehive handle



CTN:100PCS

**HA22-3**  
Beehive handle



CTN:500PCS

**HA33**  
Plastic beehive  
fixator (Snap fastener)

## Other accessories >>



**HA32**  
Beehive number mark  
CTN:720PCS



**HA32-2**  
Beehive number  
mark  
CTN:600PCS



**HA32-3**  
Beehive number mark  
CTN:500PCS



**HA32-4**  
Hive number mark  
CTN:80PCS



**HA46**  
Antproof stand  
CTN:150PCS



**HA19**  
Anti-glare film  
CTN:150PCS  
Size:500\*270/ 500\*430



**HA13**  
Foam beehive  
plastic bottom plate  
CTN:1120PCS

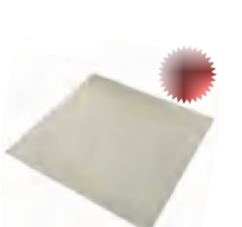

**HA44**  
Stainless steel net  
CTN:100PCS  
Size:can be customized



**HA45**  
Galvanized hive cover  
CTN:5PCS  
Size:can be customized

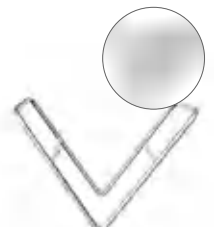

**HA47**  
Beehive carry  
CTN:5PCS  
Material: galvanized iron





# Frames



## Model: F25

BB Comb honey frame

483\*227\*42mm  
(three layers)

483\*159\*42mm  
(two layers)

Without honey comb cassettes

Patent No.:202030368092. 5

Patent No.:202030783832. 1

CTN: 20/40PCS



## Model: F25-3

BB Honey comb cassettes 250g

106.5\*68\*36 mm

Material: PS

patent No.:202030368092. 5

patent No.:202030783832. 1

CTN: 150PCS







# Frames

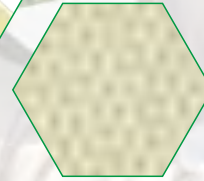
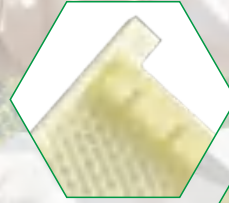

## Model: F06

Plastic frame with comb foundation

- Anti-beetles design
- ABS Food Grade
- 483\*232mm
- 483\*175mm
- 483\*159mm

CTN: 20PCS

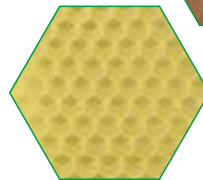

## Model: F04

Assembled frame with wax sheet

Material: New Zealand pine without knot  
SUS 201, 30% beeswax foundation sheet

483\*232/159/136\*36mm

Other size could be customized

CTN: 20PCS

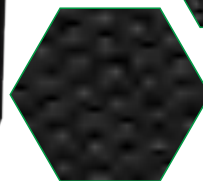

## Model: F07

Plastic frame with comb foundation

- Material: ABS
- 483\*232mm
- 483\*175mm
- 483\*159mm
- 483\*125mm

CTN: 50PCS



# Frames



CTN: 20PCS

## F02-2

Assembled wood frame with plastic foundation sheet

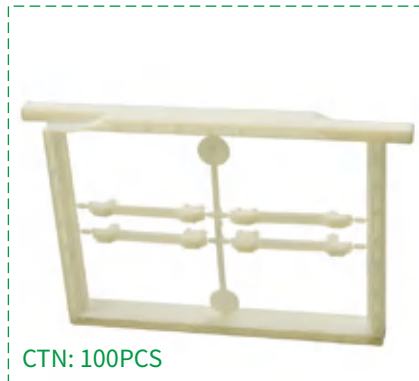

CTN: 100PCS

## F20

Plastic frame for mating nuc box



CTN: 20PCS

## F24

Plastic combination frame



CTN: 60/88PCS

## F21/F22

Honey comb (Large/Small)



CTN: 100PCS

## F26

Comb honey frame fixer

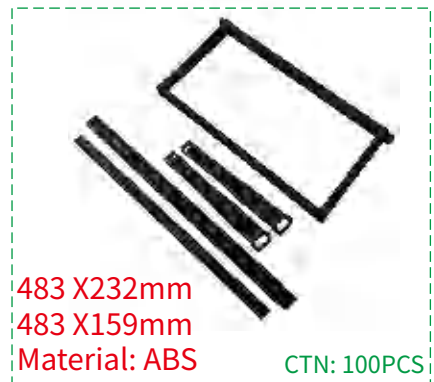

483 X232mm  
483 X159mm  
Material: ABS

CTN: 100PCS

## F23

BB Plastic combination frame



CTN: 1PCS

## F28

Pollen frame  
Match with F27



CTN: 100PCS

## F28-2

Pollen frame  
Match with F27



CTN: 400PCS

## F27

Pollen collector  
Match with F27 or F28-2





# Frames



OEM/ODM available >>



CTN: 100PCS

**F01**  
Unassembled langstroth frame  
483X232/159/136X36mm



CTN: 20PCS

**F02**  
Assembled langstroth frame  
483X232/159/136X36mm



CTN: 20PCS

**F03**  
Wired langstroth frame  
483X232/159/136X36mm

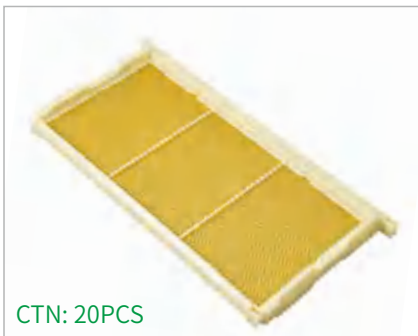

CTN: 20PCS

**F09**  
Detachable plastic frame  
485X235X28mm



CTN: 19PCS

**F18** (With cage)  
Queen bee rearing frame  
483\*232mm (Customize size available)



CTN: 3200PCS

**F15**  
Frame spacer  
Weight:5.5g



CTN: 40PCS

**F10**  
250g comb honey frame  
483X240X448mm



CTN: 150PCS

**F10B**  
Comb honey box 250g  
104X72X42mm



CTN: 40PCS

**F11**  
500g comb honey frame  
483X228X448mm



CTN: 100PCS

**F11B**  
Comb honey box 500g  
141X99X44mm



CTN: 15PCS

**F12**  
Heart-shaped comb honey frame



CTN: 200PCS

**F12B**  
Fully transparent heart-shaped comb honey box

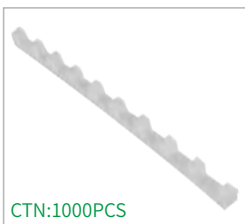

CTN:1000PCS

**F13**  
Plastic frame spacer  
Material:PP



CTN:260PCS

**F14**  
Frame ranging tool (9frames)  
Material:ABS



CTN:220PCS

**F14-2**  
Frame ranging tool (7frames)  
Material:ABS



CTN:260PCS

**F14-3**  
Frame ranging tool (8 frames)  
Material:ABS



CTN:100PCS

**F14-4**  
9 frames metal spacing tool  
Material:SUS201



# Comb foundation



OEM/ODM available >>



## Model : CF07

BB Plastic foundation  
wax roller machine

Size: 470\*590\*420mm

Material: Stainless steel

**Patented product**

Appearance Patent No.:202230075247.5

Utility Model PatentNo.:202220388560.9

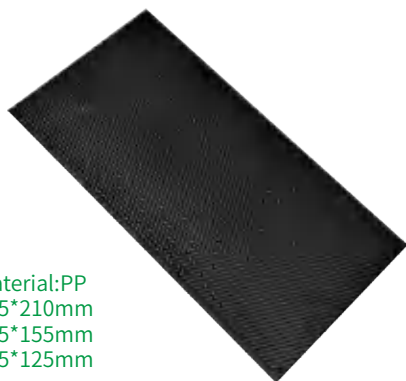

Material:PP  
425\*210mm  
425\*155mm  
425\*125mm

CTN: 200PCS

## Model: CF02

Plastic comb foundation  
(Rotational molding)



Material:PS 425\*280mm  
425\*212mm 425\*212mm  
425\*161mm 425\*157mm  
425\*141mm 425\*125mm  
425\*121mm 425\*115mm

CTN: 200PCS

## Model:CF03

Plastic comb foundation  
(Injection molding)



Material:ABS  
425\*212mm  
425\*141mm  
Color: yellow

CTN: 100PCS

## Model : CF06

Plastic comb foundation  
(Injection molding)



CTN: 30PCS

## Model: CF01

Pure beeswax content: 30%~100%  
Ceus size:4.75~5.4mm  
(Customized)



# Economy wire tools



OEM/ODM available >>

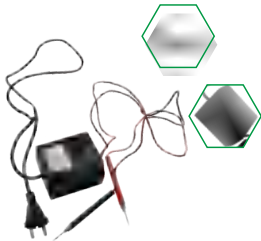

**Model: WT01-9**  
Electric wire embedder



**Model: WT01-8**  
Electric beeswax foundation embedder

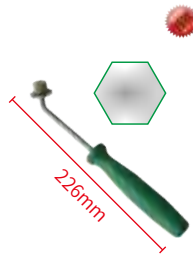

**Model: WT01-11**  
Plastic handle Spur wire embedder

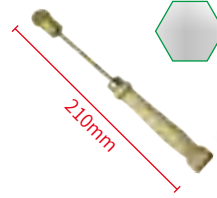

**Model: WT01-4**  
Spur wire embedder



**Model: WT01-12**  
Wire embedder(Electric)

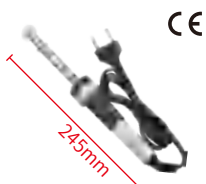

**Model: WT01-6**  
● Patented product  
BB wire embedder  
(Electric)



**Model: WT01-5**  
● Patented product  
Electric wire embedder

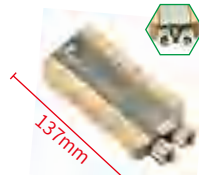

**Model: WT02-3B**  
● Patented product  
BB Wire crimper(Stainless)



**Model: WT02**  
Bee frame tensioner



**Model: WT01-13**  
Wire embedder



**WT01**  
Economy wire embedder

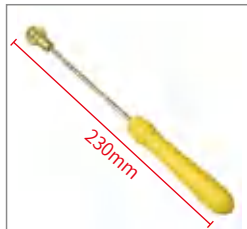

**WT01-3**  
Wire embedder

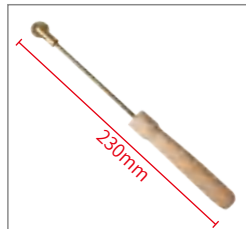

**WT01-2**  
Wire embedder

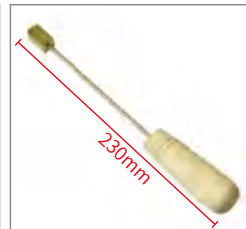

**WT01-7**  
Wire embedder



**WT01-10**  
Spur embedder



**WT02-2**  
Bee frame tensioner



**WT02-4**  
Bee frame tensioner



**WT02-6**  
Wire crimper  
(Stainless)



**WT05-2**  
Wood handle needle



**WT05-3**  
Plastic handle needle

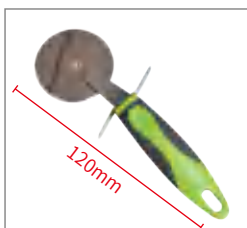

**WT08**  
Beeswax septum knife



**WT04**  
Wire pilers

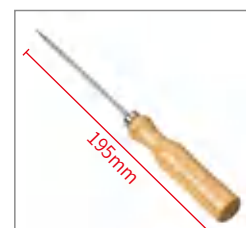

**WT05**  
Needle

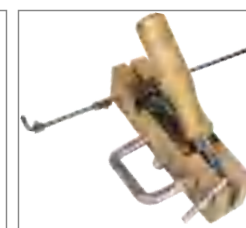

**WT06**  
Frame puncher



**WT06-2**  
Frame puncher





# Economy wire tools



### Model: WT13

Pure copper eyelet (1KG/BAG)

- Size: 4.5mm X 2.5mm X 2.5mm  
6mm X 5mm X 3mm
- CTN: 50PCS



### Model: WT14

Iron eyelets(1KG/BAG)

- Size: 4.5mm X 4.5mm X 2.5mm  
6.5mm X 5mm X 3mm
- CTN: 25PCS



### Model: WT15

304 stainless steel eyelets(1KG/BAG)

- Size: 4.5mm X 4.5mm X 2.5mm  
6.5mm X 5mm X 3mm
- CTN: 25PCS



### Model: WT07-2

Frame threading rack

- Material: IRON
- CTN: 14PCS



### Model: WT16

Foundation clip nail(1000pcs/bag)

- Width: 0.55cm
- Length: 2.55cm
- Opening: 0.25cm
- CTN: 10PCS



### Frame wires

Model	Material	Wire diameter	Gram
WT10	Galvanized	0.55/0.4mm	250g, 500g, 1000g
WT11	SUS201	0.55/0.4mm	250g, 500g, 1000g
WT12	SUS304	0.55/0.4mm	250g, 500g, 1000g



WT03  
Wire cutter  
CTN: 200PCS



WT03-2  
Wire fixator  
CTN: 50PCS



WT03-3  
Wire cutter  
(Wooden shaft)  
CTN: 40PCS



WT06-3  
EU Hole Punch



WT07  
Frame threading rack  
CTN: 14PCS



# Bundle tools



**Model: BT01**  
Beehive cargo lashing  
Rope length:5M  
CTN: 50PCS



**Model: BT01-2**  
Beehive cargo lashing  
with hook  
Rope length:5M  
CTN: 42PCS



**Model: BT03**  
Metal beehive tie  
down strap  
Rope length:10M  
CTN: 10PCS



**Model: BT02-4**  
Beehive tie strap(Australian)  
Rope length:5M  
CTN: 25PCS



**Model: BT02**  
Metal beehive tie down strap  
Rope length:5M  
CTN: 25PCS



**Model: BT02-2**  
Nylon beehive cargo lashing  
Rope length:5M  
CTN: 20PCS



**Model: BT04**  
Beehive tie-down  
strap (Australia style)  
Rope length:5M  
CTN: 100PCS



**Model: BT09**  
Beehive tie strap(304)  
Rope length:3M  
CTN: 60PCS



**Model: BT06**  
Beehive tie-down  
strap (Green with hook)  
Rope length:1.25M  
CTN: 240PCS



**Model: BT07**  
Beehive tie-down  
strap (American style)  
Rope length:3M  
CTN: 50PCS



**Model: BT08**  
Beehive tie-down  
strap (European style)  
Rope length:5M  
CTN: 60PCS





# Queen excluders

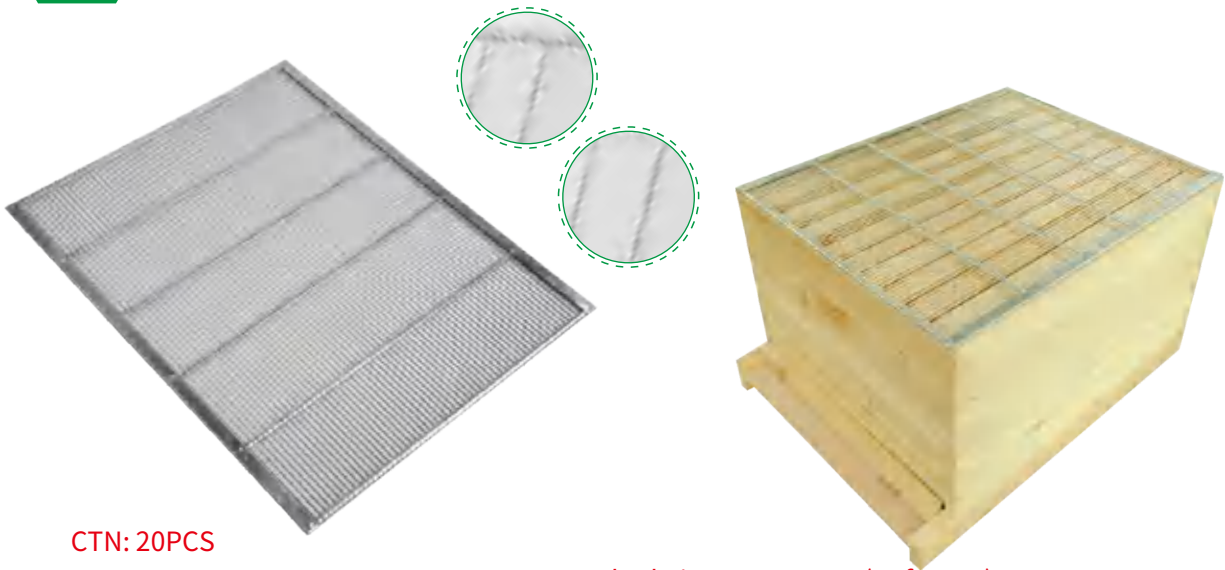

CTN: 20PCS

## Model: EC01-2

American style metal queen excluder

Standard size: 510x410mm (10 frames)  
510x360mm (8 frames)

The material or sizes can be customized as per customer's request

Galvanizing, Chromium plating, stainless steel materials are available. Precision wire spacing ensures your queen stays in the brood chamber. Product is highly durable and very easy to use. Able to supply all excluder sizes up to 550\*600mm.

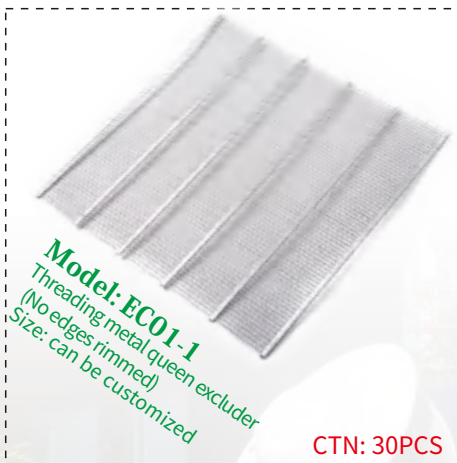

**Model: EC01-1**  
Threading metal queen excluder  
(No edges rimmed)  
Size: can be customized

CTN: 30PCS

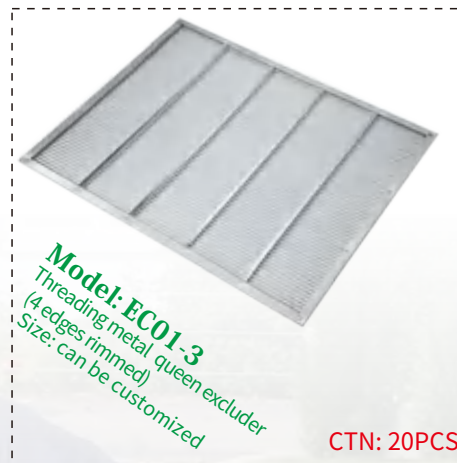

**Model: EC01-3**  
Threading metal queen excluder  
(4 edges rimmed)  
Size: can be customized

CTN: 20PCS



**Model: EC01-4**  
Metal queen excluder  
(4 edges wooden)  
Size: can be customized

CTN: 25PCS



**Model: EC01-5**  
Threading metal queen excluder  
(4 wide edges rimmed)  
Size: can be customized

CTN: 20PCS



**Model: EC01-6**  
US style queen excluder  
(4 wide edges rimmed)  
Size: can be customized

CTN: 20PCS





# Queen excluders

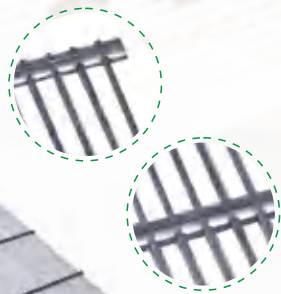
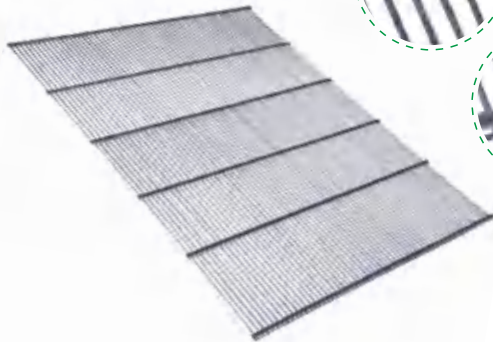

## Model: EC02/EC02B

Style queen excluder (No edges rimmed)

Material: SS304 or SUS201

Wire diameter: 1.9mm

Clearance: 4.2mm

CTN: 20PCS

The material or sizes can be customized as per customer's request

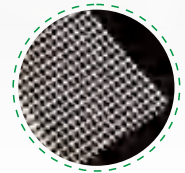
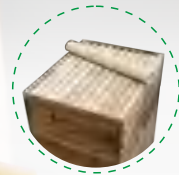

## Model: EC09-3

Propolis collector

Material: PVC

Aperture: 1.5\*1.5mm

Single weight: 45g

CTN: 1000PCS

Galvanizing, Chromium plating, stainless steel materials are available. Precision wire spacing ensures your queen stays in the brood chamber. Product is highly durable and very easy to use. Able to supply all excluder sizes up to 550\*600mm.

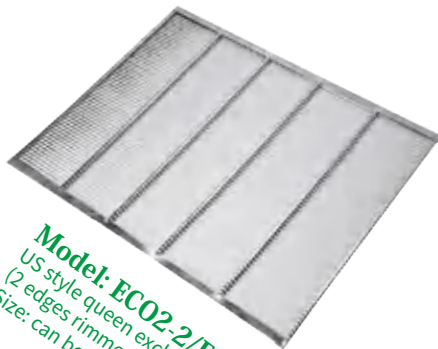

**Model: EC02-2/EC02B-2**  
US style queen excluder  
(2 edges rimmed) SUS304/SUS201  
Size: can be customized

CTN: 20PCS

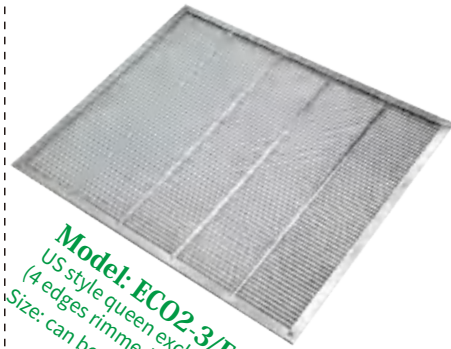

**Model: EC02-3/EC02B-3**  
US style queen excluder  
(4 edges rimmed) SUS304/SUS201  
Size: can be customized

CTN: 20PCS

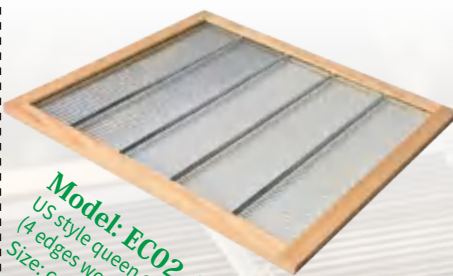

**Model: EC02-4/EC02B-4**  
US style queen excluder  
(4 edges wooden) SUS304/SUS201  
Size: can be customized

CTN: 20PCS



**Model: EC02-5/EC02B-5**  
US style queen excluder  
(4 wide edges rimmed)  
SUS304/SUS201  
Size: can be customized

CTN: 20PCS





# Queen excluders

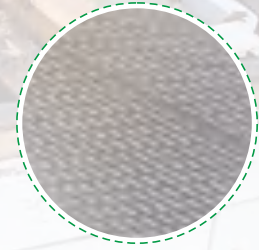
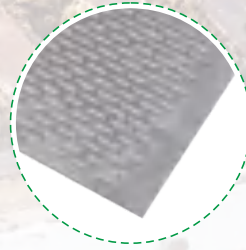

## Model: EC03

CTN: 50PCS

Aluminium queen excluder

Made of durable, high-quality Aluminium. This unit is very sturdy and with smooth surface and edges which bees pass through comfortably.

● Sizes can be customized



**Model: EC07**  
Bamboo queen excluder  
Material: bamboo

CTN: 25PCS



**Model: EC07-3**  
Bamboo queen excluder  
Material: bamboo

CTN: 50PCS



**Model: EC08**  
Plastic queen vertical excluder  
Material: ABS  
Size: 490X260mm

CTN: 40PCS

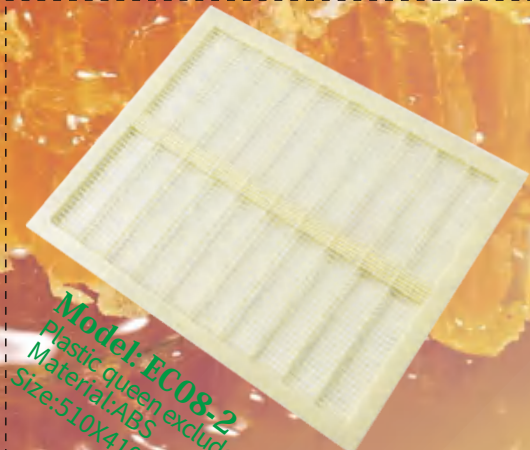

**Model: EC08-2**  
Plastic queen excluder  
Material: ABS  
Size: 510X410mm

CTN: 40PCS





# Queen excluders



The material or colors can be customized as per customer's request

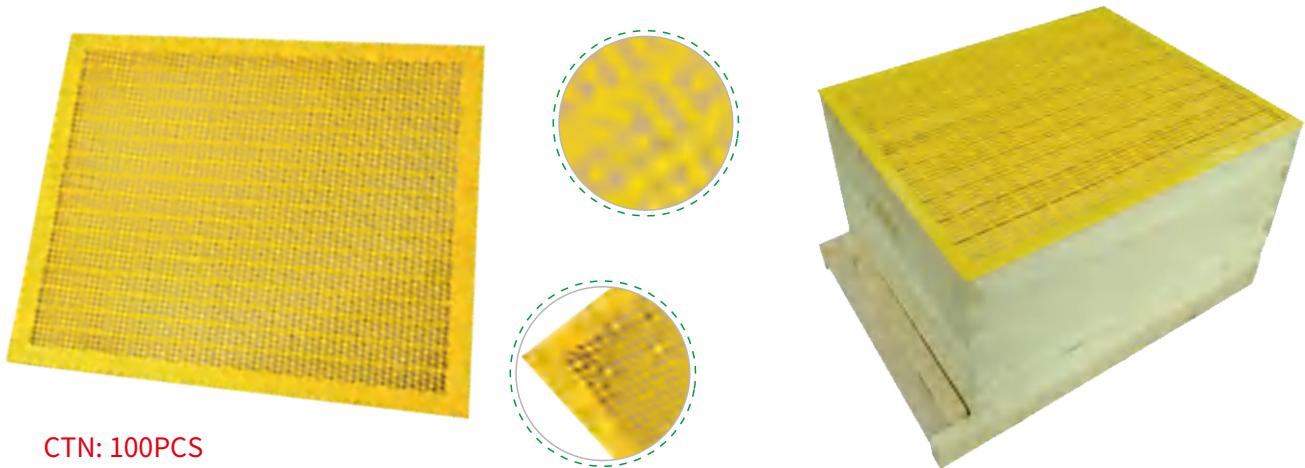

CTN: 100PCS

**Model: EC05** Plastic queen excluder (color can be customized)

### Available specifications:

510X410mm	500X500mm	510X425mm	500X450mm
510X360mm	460X460mm	485X400mm	505X360mm
506X406mm	510X420mm	435X435mm	506X360mm
506X353mm	500X425mm	470X410mm	500X430mm

Serves as a selective barrier inside the hive, limiting where the queen and drones can travel.

- \*Allows bees to pass through more readily.
- \*Precise spacing and no rough edges to harm your bees.
- \*Excellent plastic quality.
- \*Easy to clean and corrosion proof.
- \*Many sizes available.



CTN: 50PCS

**Model: EC06**

Plastic queen excluder (color can be customized)

### Available specifications:

510\*410mm/460\*460mm/435\*435mm/  
506\*406mm/506\*353mm/500\*500mm/470\*410mm

Alternate permutation Not hurting bees





# Queen excluders

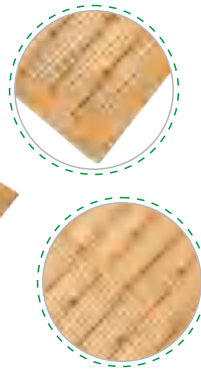

CTN: 50PCS  
Material:PP

**Model: EC09-1** Propolis collector

## Available specifications:

410X510mm	420X510mm	435X435mm	460X460mm
470X410mm	470X470mm	485X478mm	485X400mm
500X425mm	500X430mm	500X500mm	500X450mm
505X360mm	506X353mm	506X406mm	510X425mm
510X360mm			

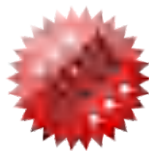

CTN: 45PCS  
Material:PP

**Model: EC09-2**

New Zealand style Propolis collector

## Available specifications:

500X400mm

Collect more propolis than regular 4mm mesh mats, easy to clean up

surface painted  
Size: customizable

**Model: EC12**

Painting metal queen excluder

**Wire diameter: 1.9mm**

**Gap: 4.2mm**

size: customizable, surface painted



# Pollen traps



- Can be hooked on hive
- Pollen trap can be pulled and pushed



## Model: PT02

Pollen trap

Weight: 507g

Size: 305X105X145mm

CTN: 20PCS



- High quality plastic material



PT01  
Pollen trap

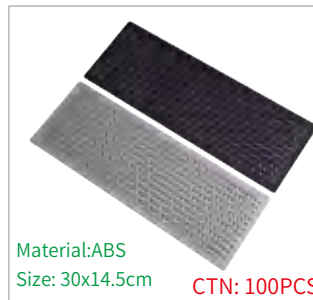

PT07  
Pollen trap

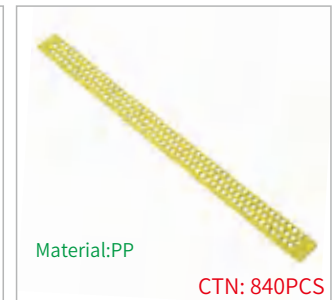

PT04  
Pollen trap

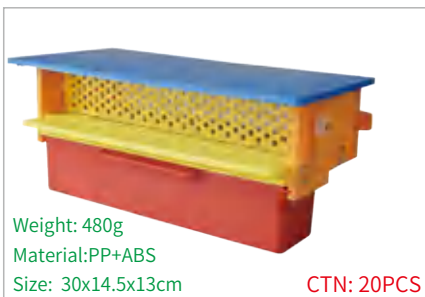

PT08  
Pollen trap

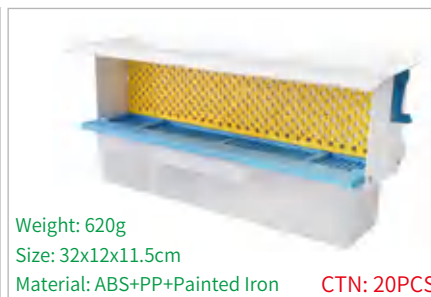

PT09  
Pollen trap



PT10  
Frame gripper





# Bee feeders

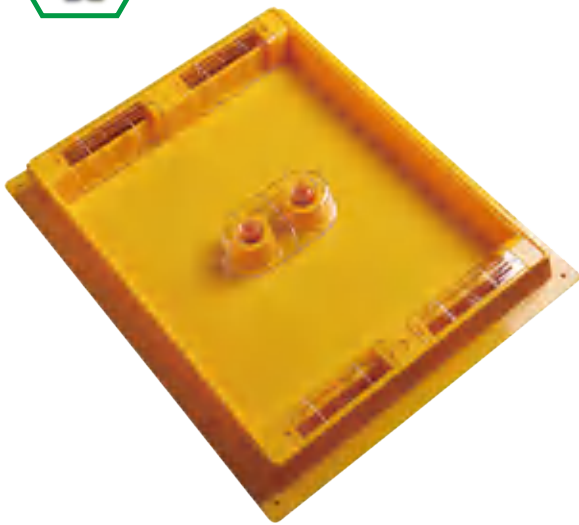

## BB Top feeder (Australia style 3.5L/2.5L)

Size: 505\*405mm/506\*353mm CTN: 20PCS

Appearance Patent No.: 201930629685.X

Utility Model Patent No.: 201921966873.2

## BB Top feeder (US style 4.5L)

Size: 505X405mm CTN: 10PCS

Appearance Patent No.: 201930629684.5

Utility Model Patent No.: 201921966873.2

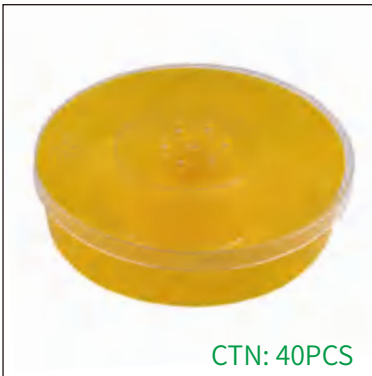

CTN: 40PCS

### FD08-3

Top feeder (1.3L)  
Size: 210X55mm



CTN: 54PCS

### FD08-4

Top feeder (1.7L)  
Size: 217X85mm



CTN: 50PCS

### FD08

PP Top feeder (1.3L)  
Size: 260X55mm

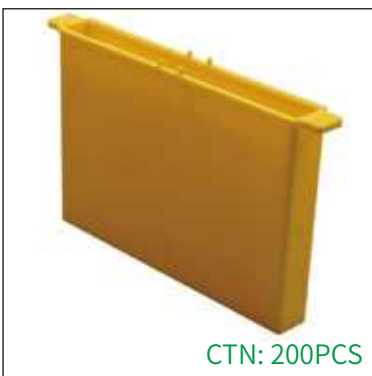

CTN: 200PCS

### FD19

Division feeder (0.5L)  
Size: 25X3.3X15cm

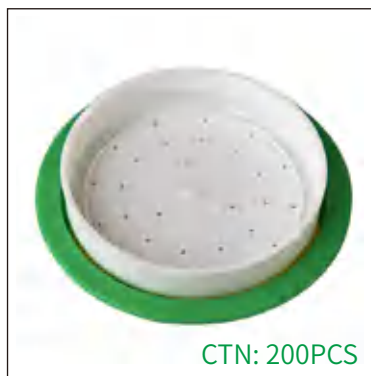

CTN: 200PCS

### FD21

Boardman feeder  
Diameter: 75mm

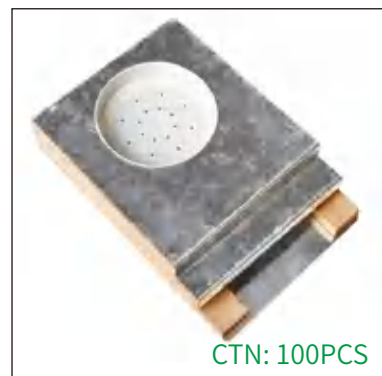

CTN: 100PCS

### FD22

Boardman feeder  
(Pine + Galvanized Iron)  
Size: 170X113X35mm





# Bee feeders



CTN: 30PCS



• **FD02-2 (4L)**  
Size:483\*55\*220mm  
Weight:620g

• **FD02 (6L)**  
Size:483\*80\*230mm  
Weight:850g

• **FD01 (6L)**  
Size:483\*80\*230mm  
Weight:850g

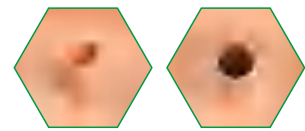
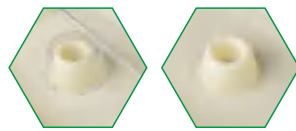

**Model: FD07**  
390X370X70mm  
Capacity: 6L  
CNT:10PCS

**Model: FD07B**  
390x330x75mm  
Capacity: 6L  
CNT:10PCS

**Model: FD18**  
180X180x55mm  
Capacity: 1.6L  
CNT:60PCS

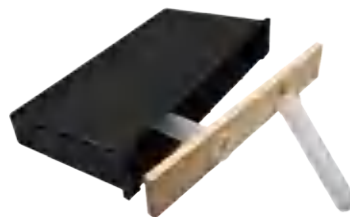

**FD02-3**  
Size:233X120X25mm  
Capacity: 0.5L  
CNT:50PCS

**FD06**  
Size:483X35X240mm  
Capacity: 4L  
CNT:12PCS

**FD01W**  
Size:483X80X230mm  
Capacity: 6L  
CNT:25PCS

**FD14**  
Size:483X80X230mm  
Weight: 340g  
CNT:20PCS



# Bee feeders



**Model: FD11**  
**(1.5L)**  
Material:PP+ABS  
CTN: 50PCS



**Model: FD15**  
**(1 L)**  
Material:PP  
CTN: 100PCS



**Model: FD17**  
**(0.5L)**  
Material:PP  
CTN: 150PCS



**FD03 (0.75L)**



**FD03-2 (1.5L)**



**FD03-3 (3L)**

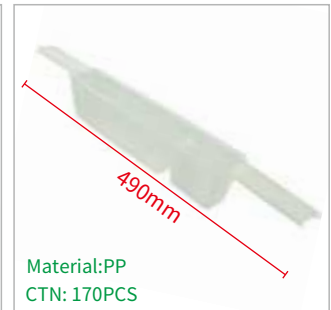

**FD03-4 (1L)**



**FD03-5 (0.6L)**



**FD03-6 (1.6L)**



**FD04 (0.5L)**



**FD05**



**FD09**



**FD10**



**FD12**



**FD16**



# Bee smokers

Benefitbee®

OEM/ODM available >>

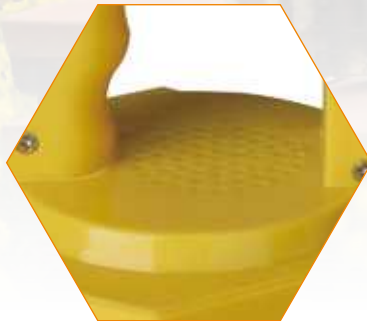

## Patented product

Patent No.: 202030576923.8

Model	S12
Size	13.7*29*27cm
Material	PC+SUS201
CTN	20PCS







# Bee smokers

Benefitbee®

OEM/ODM available >>

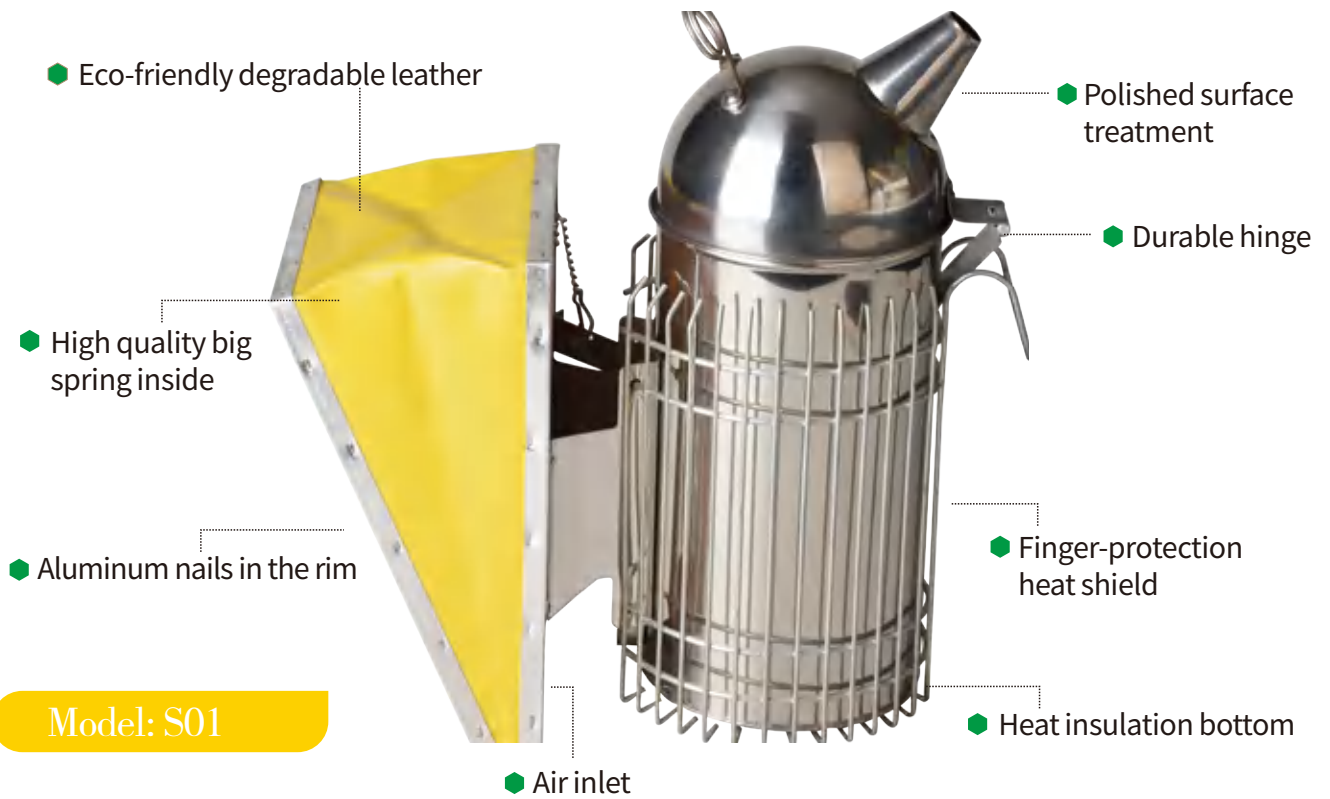
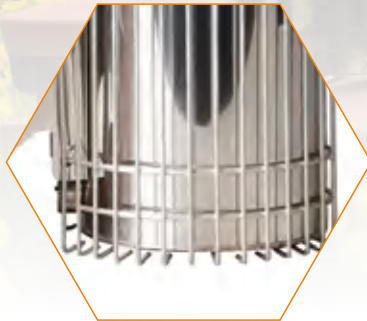

Model: S01

<b>Model</b>	S01-L	S01
<b>Size</b>	L Φ:10cm h:30cm	M Φ:10cm h:26cm
<b>Material</b>	SUS201	
<b>CTN</b>	20PCS	





# Bee smokers



OEM/ODM available >>

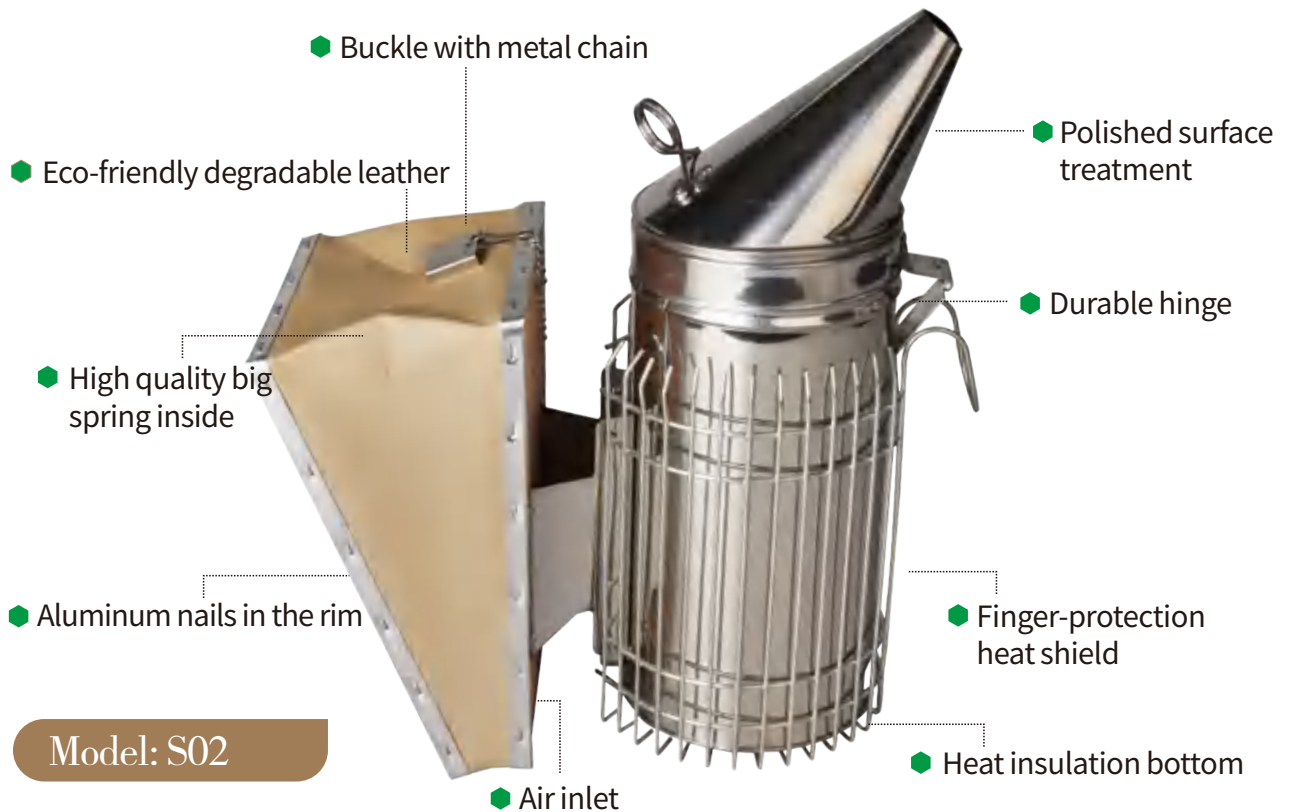

Model: S02

<b>Model</b>	S02-L	S02
<b>Size</b>	L $\Phi$ :10cm h:32cm	M $\Phi$ :10cm h:29cm
<b>Material</b>	SUS201	
<b>CTN</b>	20PCS	







# Bee smokers

Benefitbee®

OEM/ODM available >>



Model	S03
Size	Φ:10cm h:29cm
Material	SUS201
CTN	20PCS

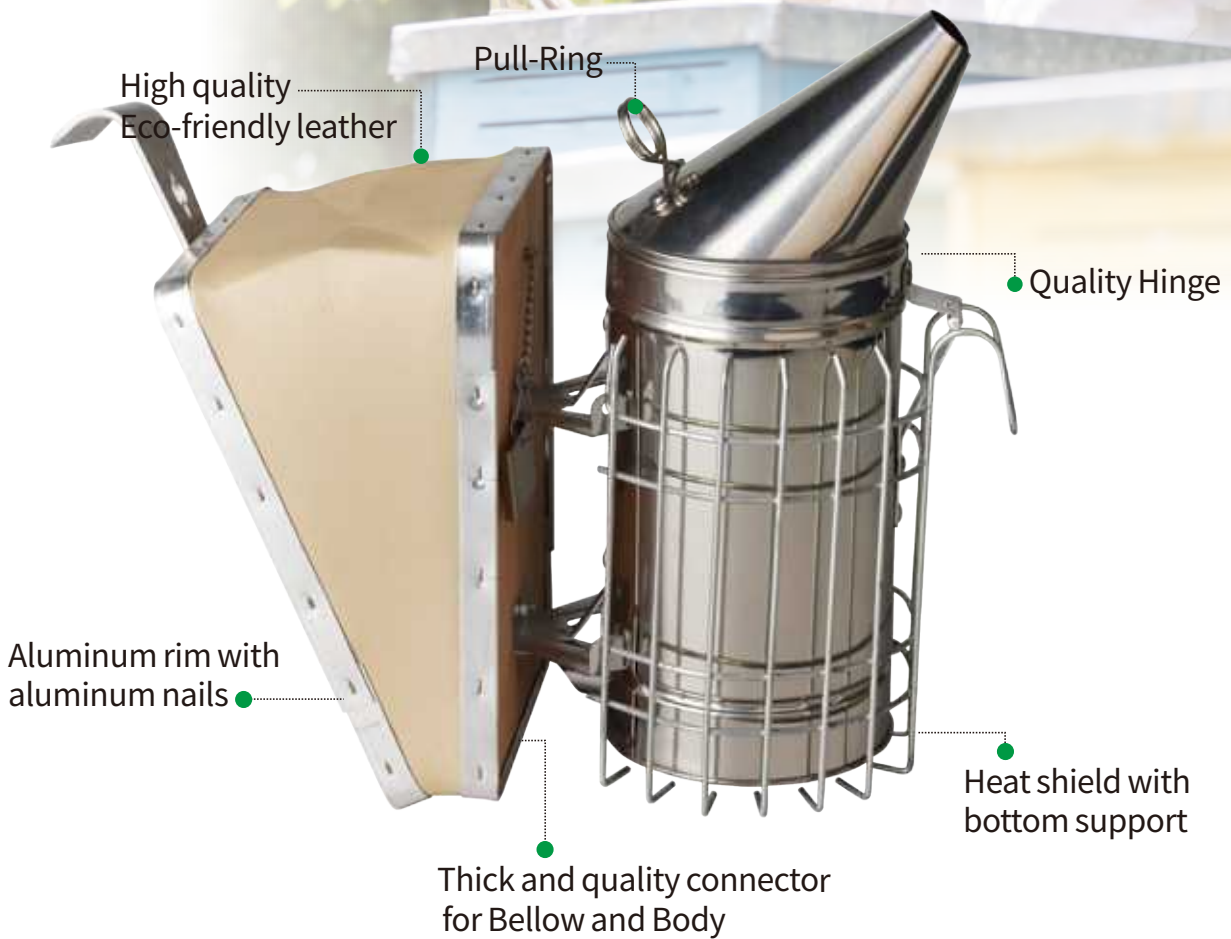





# Bee smokers

OEM/ODM available >>



<b>Model</b>	S13-L	S13
<b>Size</b>	L $\Phi$ :10.5cm h:34cm	M $\Phi$ :10.5cm h:28cm
<b>Material</b>	SUS201	
<b>CTN</b>	20PCS	





# Bee smokers



OEM/ODM available >>



Model	S04-L	S04
Size	L $\Phi$ :10cm h:32cm	M $\Phi$ :10cm h:29cm
Material	SUS201	
CTN	20PCS	



Model	S05-L	S05	S05-S
Size	L $\Phi$ :10cm h:29cm	M $\Phi$ :10cm h:24cm	S $\Phi$ :8.5cm h:21cm
Material	SUS201		
CTN	10PCS	15PCS	15PCS



Model	S06-L	S06	S06-S
Size	L $\Phi$ :10cm h:31cm	M $\Phi$ :10cm h:28cm	S $\Phi$ :8.5cm h:26cm
Material	SUS201		
CTN	10PCS	15PCS	15PCS



Model	S07-L	S07	S07-S
Size	L $\Phi$ :10cm h:31cm	M $\Phi$ :10cm h:28cm	S $\Phi$ :8.5cm h:26cm
Material	Galvanized		
CTN	10PCS	15PCS	15PCS



# Bee smokers



OEM/ODM available >>

**Model : SP06**

**Smoker box**

(This product does not include smoker)

Material: iron chrome plated  
201 stainless

Product size: 24.5x15.4x37.5cm

CTN: 10PCS



Can be equipped with inner tank



CTN: 20PCS

Size:20cm\*Φ7.5cm

**Model : S05-BS**

Smoker(Economic XS)

Material:SUS201



CTN: 18PCS

Size:26cm\*Φ10cm

**Model : S17**

Smoker(Italian style L/M/S)

Material:SUS201



CTN: 20PCS

Φ:10cm  
H:24cm  
W:21cm

**Model : S15**

Smoker(European style)



CTN: 3PCS

Φ:15cm  
H:43cm  
W:25cm

**Model : S14**

Smoker(South America)



CTN: 5PCS

Φ:10cm  
H:24cm  
W:21cm

**Model : S16**

Smoker(European style electric)





# Bee smokers

OEM/ODM available >>



**Model: S11**  
CTN: 4PCS  
l:33cm  
w:13cm  
h:40cm



**Model: S11-2**  
CTN: 4PCS  
L:33cm  
W:13cm  
H:40cm



**Model: S10**  
CTN: 15PCS  
Φ:8.5cm  
h:26cm



**Model: S08**  
CTN: 40PCS  
Φ:6.5cm  
h:18cm



**Model: S09**  
CTN: 10PCS  
Φ:10cm  
h:28cm



**Model: S09-2**  
CTN: 15PCS  
Φ:10cm  
h:26cm



# Bee smokers

Benefitbee®

OEM/ODM available >>

Cow leather



**SP01**

CTN: 100PCS

Micro leather



**SP01-2**

CTN: 60PCS

PU



**SP01-3**

CTN: 60PCS

Plastic



**SP02**

CTN: 60PCS

Stainless steel



**SP04**

CTN: 500PCS

Smoker fuel



**SP05**

CTN: 100PCS



**SP03**

CTN: 100PCS



**SP03-S**

CTN: 100PCS



**SP05-2**

CTN: 200PCS



# Honey extractors

Benefitbee®

OEM/ODM available >>

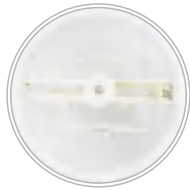

**HE01**

2 frames plastic  
manual honey extractor  
CTN: 1PCS



**HE03-2**

Economy 2 frames  
manual honey extractor  
CTN: 1PCS



**HE04-2**

Economy 2 frames  
manual honey extractor  
CTN: 1PCS

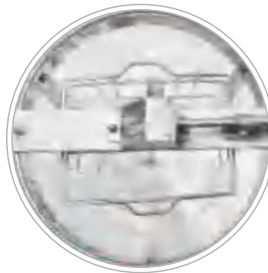

**HE02-2**

2 frames full transparent  
manual honey extractor  
CTN: 1PCS



**HE02-3**

3 frames full transparent  
manual honey extractor  
CTN: 1PCS



**HE05-2**

2 frames manual self  
reversal honey extractor  
CTN: 1PCS



**HE05-3**

3 frames manual self  
reversal honey extractor  
CTN: 1PCS



**HE05-4**

4 frames manual self  
reversal honey extractor  
CTN: 1PCS





# Honey extractors



OEM/ODM available >>



**Model:HE06-2**  
2 frames manual  
honey extractor  
CTN: 1PCS



**Model:HE06-3**  
3 frames manual  
honey extractor  
CTN: 1PCS



**Model:HE06-4**  
4 frames manual  
honey extractor  
CTN: 1PCS



**Model:HE06-2E**  
2 frames electric  
honey extractor  
CTN: 1PCS



**Model:HE06-3E**  
3 frames electric  
honey extractor  
CTN: 1PCS



**Model:HE06-4E**  
4 frames electric  
honey extractor with  
CTN: 1PCS



**Model:HE06-6**  
6 frames manual  
honey extractor  
CTN: 1PCS



**Model:HE06-8**  
8 frames manual  
honey extractor  
CTN: 1PCS



# Honey extractors



OEM/ODM available >>

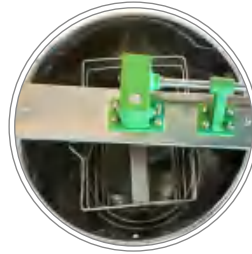

**Model : HE12-2**  
Extractor  
(2 frames manual brake)  
CTN: 1PCS



**Model : HE12-3**  
Extractor  
(3 frames manual brake)  
CTN: 1PCS



**Model : HE12-4**  
Extractor  
(4 frames manual brake)

Barrel height: 60CM  
Diameter: 48CM  
Total height: 110cm  
Inner frame material : sus304  
Barrel body material : sus201  
Rack:45X26cm  
CTN: 1PCS



**HEPJ01/-2/HEPJ03**

2/3/4/6/8 frame manual gear assembly  
4 frames have other specifications



**HEPJ02/-2/HEPJ04**

2/3/4/6/8 frame manual gear assembly + beam



**HEPJ16**

Handle



# Honey extractors



OEM/ODM available >>



**Model:HE06-6E**  
6 frames electric honey extractor  
CTN: 1PCS



**Model:HE06-8E/HE06-12E  
HE06-20E/HE06-24E**  
8/12/20/24 frames electric Honey extractor  
CTN: 1PCS



**Model:HE06-6EM**  
6 frames electric honey extractor (Three use)  
CTN: 1PCS



**Model:HE07-4**  
4 frames electric honey extractor  
CTN: 1PCS



**Model:HE08-2**  
2 frames manual self reversal honey extractor (Gear box with brake function, steering handle)  
CTN: 1PCS



**Model:HE08-3**  
3 frames manual self reversal honey extractor (Gear box with brake function, steering handle)  
CTN: 1PCS



**Model:HE08-4**  
4 frames manual self reversal honey extractor (Gear box with brake function, steering handle)  
CTN: 1PCS





# Hive tools



OEM/ODM available >>

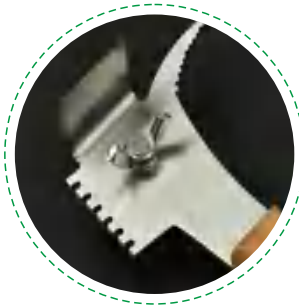

## Model: T15 Multifunctional hive tool

China Patent: ZL201520103196.7 ZL201530043392.5

High-quality stainless steel, sturdier wood, exquisite workmanship, powerful beekeeping hive tool, that incorporates up to a half dozen applications iron tool: Hive scraper, frame cleaner, nail puller, queen excluder straightener and cleaner, pry bar, detachable hammer, etc. It will last a lifetime! A must have for all beekeepers.

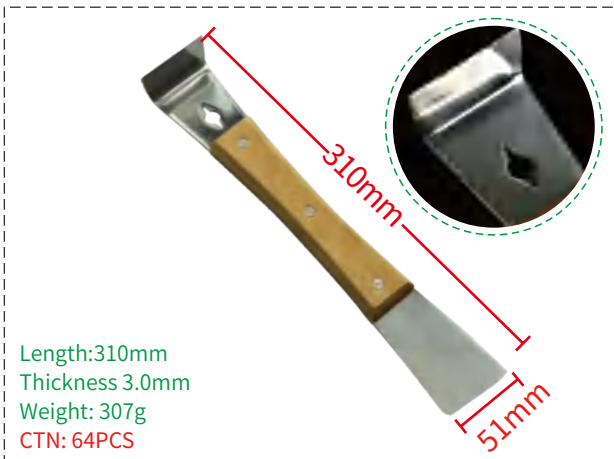

Length: 310mm  
Thickness: 3.0mm  
Weight: 307g  
CTN: 64PCS

T02-L



Material: 2CR13  
Mirror splishing & Spray paint  
CTN: 80PCS

T14

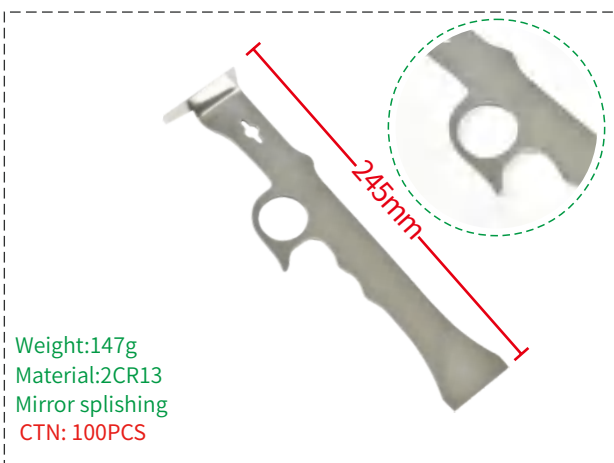

Weight: 147g  
Material: 2CR13  
Mirror splishing  
CTN: 100PCS

T24

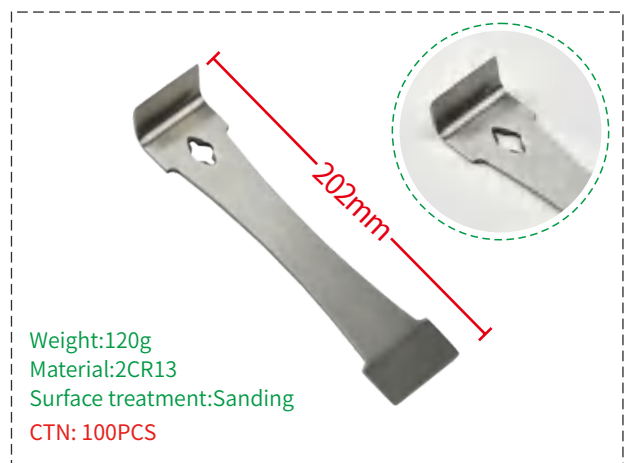

Weight: 120g  
Material: 2CR13  
Surface treatment: Sanding  
CTN: 100PCS

T19



# Hive tools



OEM/ODM available >>

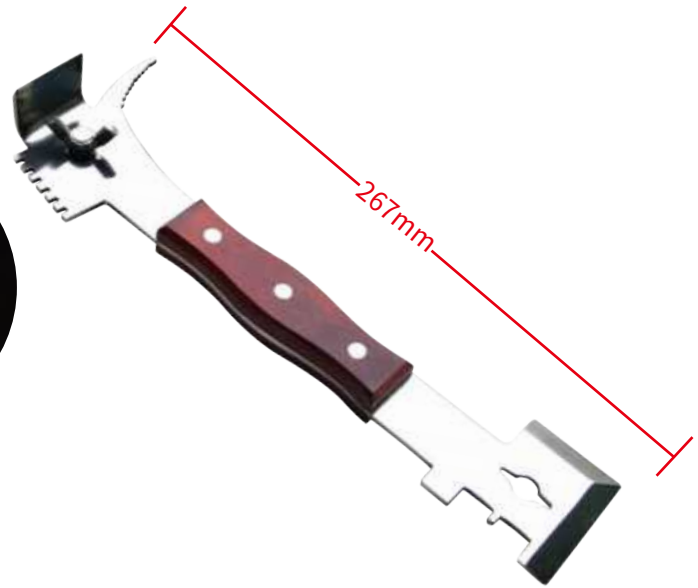

## Model: T15B

BB Multifunction hive tool(Patent)

Surface treatment: mirror luster logwood handle

Weight: 300g

Material: 2CR13

CTN: 64PCS



Material :2CR13  
Thickness :2.6-2.7mm  
Surface treatment: mirror light  
CTN: 60PCS

T01-C

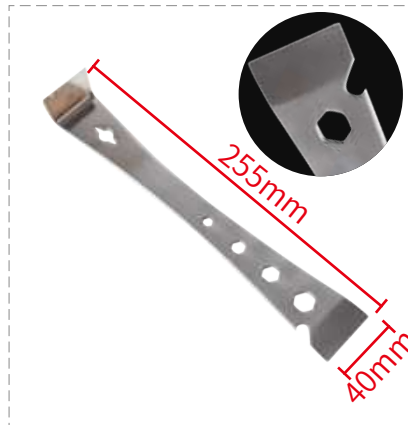

T01-D



Material :2CR13  
Thickness: 2.5mm  
Weight: 178g  
CTN: 140PCS

T01-P



Material:2CR13  
Thickness:2.5mm  
Weight:145g  
CTN: 100PCS

T01-SP



Weight:130g  
Shovel:45mm  
Material:2CR13  
Thickness:2.5mm  
CTN: 100PCS

T04-TP



Material: 430 Spring steels  
Hardness: 40,  
Single weight: 197g,  
Surface technology: spray paint  
CTN: 100PCS





T30



OEM/ODM available >>



**Model: OT01**  
Multi-function claw hammer





 <p><b>2CR13</b> 260mm</p> <p>Weight:120g CTN: 100PCS</p>	 <p><b>2CR13</b> 310mm</p> <p>Weight:115g Mirror splishing CTN: 120PCS</p>	 <p><b>2CR13 Sanding</b> 250mm</p> <p>Thickness:3.0mm Weight:154g CTN: 100PCS</p>	 <p><b>2CR13 Sanding</b> 330mm</p> <p>Thickness 3.0mm Weight:203g CTN: 80PCS</p>
--	---	---	---

**T23**

**T25**

**T28**

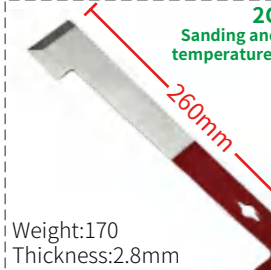
**T29**





 <p><b>2CR13 Sanding and high temperature paint</b> 240mm</p> <p>Weight:145g Thickness:2.5mm CTN: 100PCS</p>	 <p><b>2CR13 Sanding and high temperature paint</b> 260mm</p> <p>Weight:170g Thickness:2.8mm CTN: 100PCS</p>	 <p><b>2CR13 Sanding and high temperature paint</b> 260mm</p> <p>Weight:170 Thickness:2.8mm CTN: 100PCS</p>	 <p><b>2CR13 &amp; Wooden handle Sanding</b> 190mm</p> <p>Weight:90g CTN: 160PCS</p>
---	---	---	---

**T01-S**

**T01-2**

**T04**

**T17**

 <p><b>2CR13 Mirror splishing</b> 310mm</p> <p>Weight:65g CTN: 320PCS</p>	 <p><b>2CR13 Splishing</b> 260mm</p> <p>Weight:164g Thickness:2.8mm CTN: 100PCS</p>	 <p><b>2CR13 Splishing</b> 285mm</p> <p>Weight:164g Thickness:2.8mm CTN: 100PCS</p>	 <p><b>Galvanized steel structure</b> 218mm</p> <p>Weight: 125g CTN: 200PCS</p>
--	--	---	--

**T20**

**T01**

**T16**

**T21**

 <p><b>2CR13</b> 220mm</p> <p>Thickness:2.4mm Weight: 112g CTN: 320PCS</p>	 <p><b>SUS430 Mirror polish</b></p> <p>CTN: 200PCS</p>	 <p><b>2CR13 Sanding</b> 285mm</p> <p>Weight:125 Thickness:2.8mm CTN: 100PCS</p>	 <p><b>2CR13 Sanding and high temperature paint</b> 260mm</p> <p>Weight:170g Thickness:2.8mm CTN: 100PCS</p>
---	---	--	---

**T22**

**T27**

**T03-T**

**T01-3**





OEM/ODM available >>



T02

T02-P

T03

T03-2



T04-T

T05

T06

T07



T08

T26

T09

T01-R

T10



T11

T12

T13

T17-2

T18



# Uncapping knives



OEM/ODM available >>



## Model: K10-Y

#304 Stainless Steel

Switch control: Long press to turn on or off, short press to switch Celsius and Fahrenheit Plus or Minus 5 unit each by pressing "+" or "-" button

Adjustable temperature: 0-180°C

Voltage:110-220V Power:300W

CTN: 25PCS

Patent No.:202030295900.X

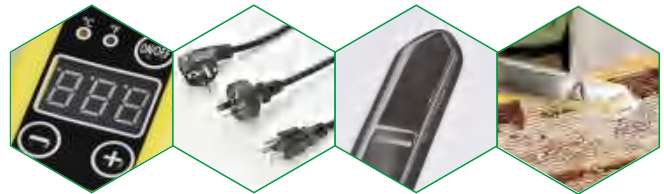

## Model: K10-E

#304 Stainless Steel

Electric heated uncapping uncaps honeycomb in a few simple swipes.

Temperature: 150-190°C

Voltage: 12V Power: 300W

CTN: 25PCS

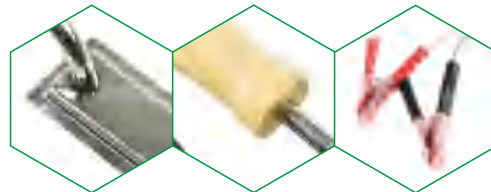

## Model: K10-T



CTN: 25PCS

#304 Stainless Steel

Electric uncapping knife with thermo regulator CE certificate. Slides right along the outer edges of the frame and makes a nice cut. ON-OFF switch attached to control temperature, avoid over-heating.

Voltage:110&220V Optional Power:300W

## Model: K10



CTN: 25PCS

#304 Stainless Steel CE certificate

Designed for easy uncapping to extract honey faster. No more messy chunks of wax in all over the place

Temperature: 150-190°C

Voltage:110-220V Power:300W



# Uncapping knives



OEM/ODM available >>



**Model:K10-TS**



**Model: K16**



**Model: K21**



**Model: K10-B**



**K11-2**

Weight:120g

CTN: 266PCS

Patent No.:201530031130.7



**K07**

Weight:126g

Thickness:1.2mm

CTN: 266PCS



**K08**

Weight:107g

Thickness:1.0mm

CTN: 250PCS



**K09**

Thickness:0.6mm

CTN: 300PCS



**K11**

Thickness:1.2mm

CTN: 140PCS



**K12**

Weight:231g

CTN: 150PCS



**K06**

Weight:190-210g

CTN: 60PCS

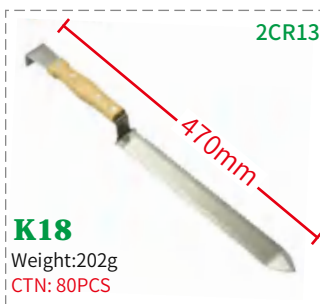

**K18**

Weight:202g

CTN: 80PCS



**K13-S**

Weight:57g

Thickness:1mm

CTN: 80PCS



**K03-L**

Weight:76g

Thickness:1mm

CTN: 200PCS



**K14**

CTN: 480PCS





# Uncapping knives



OEM/ODM available >>





# Uncapping forks



OEM/ODM available >>



**UF13-1AP**

Material:SUS304  
Handle:Plastic  
Thickness:2cm  
CTN: 80PCS



**UF13-3AP**

Material:SUS304  
Handle:Plastic  
CTN: 80PCS



**UF13-1P**

Material:SUS304  
Handle:Plastic  
Thickness:2cm  
CTN: 80PCS



**UF13-3P**

Material:SUS304  
Handle:Plastic  
CTN: 80PCS



**UF13-1A**

Material:SUS304  
Handle:eucalyptus  
CTN: 80PCS



**UF13-2A**

Material:SUS304  
Handle:wooden handle  
CTN: 60PCS



**UF13-3A**

Material:SUS304  
Handle:wooden handle  
CTN: 80PCS



**UF13-1**

Material:SUS304  
Handle:eucalyptus  
CTN: 80PCS



**UF13-2**

Material:SUS304  
Handle:wooden handle  
CTN: 80PCS



**UF13-3**

Material:SUS304  
Handle:wooden handle  
CTN: 80PCS



**UF13-4**

CTN: 80PCS



# Uncapping forks



OEM/ODM available >>



Roller length:100/150/ 200/250mm  
CTN: 100PCS



Weight:265g  
Material:pp  
CTN: 24PCS



Thickness:0.21cm  
Weight: 150g  
Material:SUS304 +PP  
CTN: 100PCS

UF14

UF06

UF12



Uncapping fork (17 needles)  
CTN: 400PCS



CTN: 48PCS



Needle thick:1.6mm  
Handle material:Aluminum&wooden  
CTN: 100PCS



Honey Uncapper  
CTN: 1PCS

UF15

UF04

UF03

UF16



Needle thickness:2.0mm  
Color: red, yellow, green  
Needle: straight/ curved  
CTN: 300PCS



Needle thickness:1.6mm  
Color: red, yellow, green  
Needle: straight/curved  
CTN: 400PCS



CTN: 180PCS

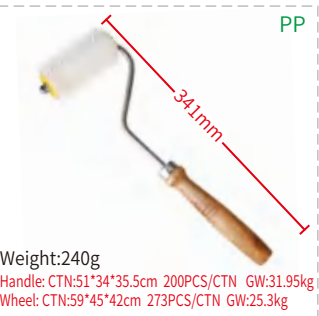

Weight:240g  
Handle: CTN:51\*34\*35.5cm 200PCS/CTN GW:31.95kg  
Wheel: CTN:59\*45\*42cm 273PCS/CTN GW:25.3kg

UF01

UF02

UF11

UF05-2



Weight:220g  
Handle: 150PCS/CTN GW:21.5kg  
Wheel: CTN:59\*45\*42cm 273PCS/CTN GW:25.3kg



Colour:Yellow  
CTN: 200PCS



Weight:85g  
Needle thickness:1.6mm  
CTN: 150PCS



CTN: 150PCS

UF05

UF07

UF08

UF09





# Frame grip tools



OEM/ODM available >>

## Model: FG18

BB Frame grip  
Product material: 201SUS

**Patented product**

Patent N o.: ZL 2022 3 0265800.1



**FG01**  
Material:SUS2CR13  
CTN:100PCS

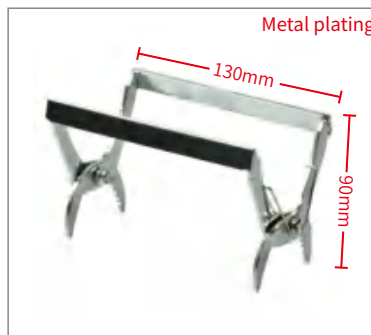

**FG02**  
Material:Iron  
CTN:100PCS



**FG03**  
Material:2CR13  
CTN:48PCS



**FG04**  
Material:Galvanized iron  
CTN:64PCS



**FG05**  
Material:Galvanized iron  
CTN:64PCS

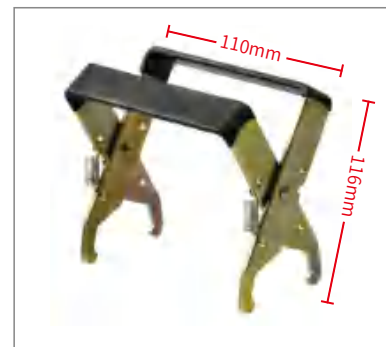

**FG06**  
Material:Galvanized iron  
CTN:60PCS



**FG07**  
Material:SUS201+Beech wood  
CTN:60PCS



**FG10**  
Material:Galvanized iron  
CTN:64PCS



**FG11**  
Material:Galvanized iron  
CTN:50PCS

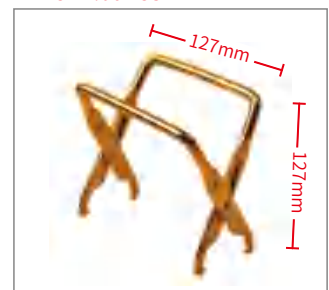

**FG12**  
Material:Aluminum  
CTN:50PCS



# Frame grip tools



OEM/ODM available >>



**FG14**  
Material:SUS201  
CTN:160PCS



**FG15**  
The lithium battery : 2000mAH  
CTN:5PCS



**FG15-2**  
Battery capacity: 2000 mAh  
CTN:5PCS

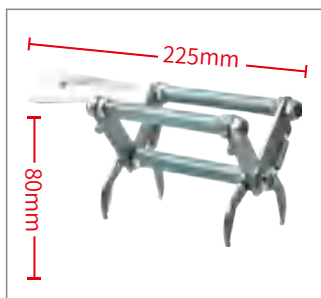

**FG09**  
Material:SUS201  
CTN:40PCS

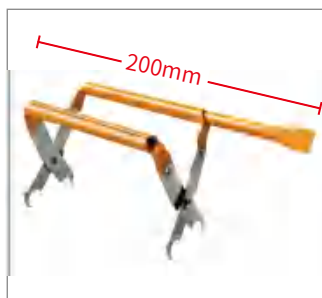

**FG08**  
Material:SUS201  
CTN:60PCS



**FG08-2**  
Material: ABS+  
Stainless steel ring  
CTN:20PCS



**FG13**  
Material:2CR13  
CTN:40PCS

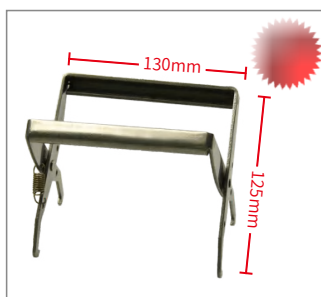

**FG16**  
Material: stainless steel  
CTN:64PCS



**FG17**  
Material:SUS201  
CTN:50PCS

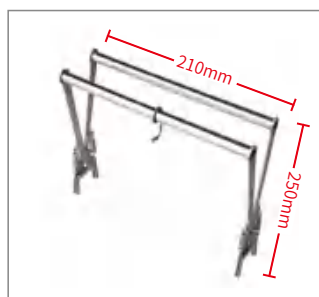

**FG17-2**  
Material:SUS201  
CTN:40PCS

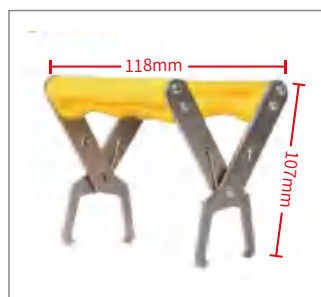

**FG07-2**  
Material:SUS201+PP  
CTN:50PCS



# Filter tools



CTN:10PCS  
Diameter:Φ320mm  
Mesh material:SUS304  
Filter screen height:65mm  
Upper layer:16 mesh  
Under layer:40 mesh

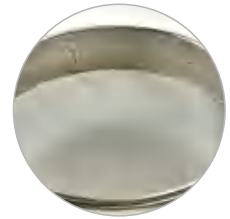
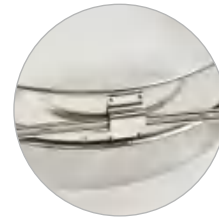

## Model: FT01B(Φ32cm)

304 STAINLESS STEEL is durable, highly resistant to rust and oxidation. Designed with two separate screens: the upper sieve removes large debris, while the lower sieve strains out fine particles. Adjustable brackets to fit dia 21-40cm bucket size, strain honey faster and easier. Easy to clean with warm soapy water and dry immediately.



## Model: FT01-3

Double strainer (Φ24cm)  
Material: SUS304 & SUS201  
Diameter: 24cm, Height: 15.3cm  
CTN:10PCS



## Model: FT11

Double honey strainer  
Mesh material:SUS304  
CTN:10PCS



FT07-3  
CTN:200PCS



Mesh material:SUS304  
Upper layer:16 mesh, Under layer:40 mesh

FT01  
CTN:10PCS



Mesh material:SUS304,  
Upper layer:16 mesh, Under layer:40 mesh

FT01-2  
CTN:10PCS



Material:SUS201

FT05  
CTN:50PCS



Material:SUS201

FT05-2  
CTN:50PCS



Material:SUS201 Under layer:40 mesh

FT06  
CTN:50PCS





OEM/ODM available >>

## Modle: FT13

### Honey comb holder uncapping tray

Size:stainless steel disc: 600\*400\*95mm

Plastic box:

External dimension: 600x400x175mm

Internal dimension: 550\*365\*160mm

Mesh material:SUS201+PP

CTN:1 PCS



## Modle: FT14

### Uncapping tray

Plastic box:

External dimension: 600x400x230mm

Internal dimension: 550\*365\*220mm

Stainless steel disc: 600\*400\*150mm

Mesh material:SUS201+PP

CTN:1 PCS

## Modle: FT15/FT16

### Honey filter

Material:Nylon,201 Stainless steel ring

#### Product Size:

ø33cm ,1 mm square mesh,length 47cm.

ø33cm ,0.3mm square mesh,length 36cm.

ø33cm ,0.2 mm square mesh,length 36cm.

ø45cm ,1 mm square mesh length 47cm.

ø45cm ,0.3 mm square mesh length 36cm.

ø45cm ,0.2 mm square mesh length 36cm.

CTN:120/200/260 PCS





# Filter tools



### Model: FT04

Double honey strainer

Size:Φ230mm,Mesh material:ABS

CTN:10PCS



### Model: FT03

Double honey strainer

Upper layer Size:Φ295mm

CTN:10PCS



Size:Φ240mm\*60mm

Mesh material:Nylon  
Case material:Nylon  
Layer:26 mesh

CTN:20PCS

### Model: FT02

Nylon double honey strainer



Material:SUS201  
Surface Treatment:  
Mirror polishing

CTN:1 PCS

### Model: FT10

Uncapping tray

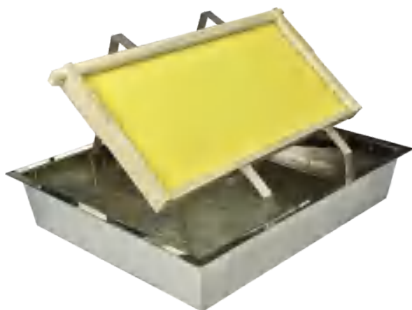

Surface Treatment: Sanding  
Material:SUS201

Size: 470\*432\*100mm

CTN:1 PCS

### Model: FT09

Uncapping tray



### Model: FT09B

Plastic uncapping tub

Material:PP

CTN:3 PCS

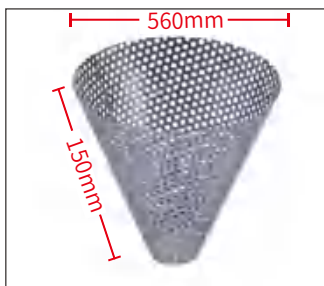

### FT18

Honey filter

(304 stainless steel)

The hole spacing is 3.0mm

CTN:10 PCS



### FT19/FT19-2

Stand for Strainer

Ø30cm/ Ø43cm

Material:SUS201

Weight: 1600g/1700g

CTN:10 PCS



### FT08

Honey filter (Thin style)

Size:35X23cm

Material:Nylon

CTN:260 PCS



### FT08-2

Honey filter

Size:50X35cm

Material:Nylon

CTN:240 PCS



# Cleaning tools



OEM/ODM available >>



CL05  
Material:SUS201  
CTN:400PCS

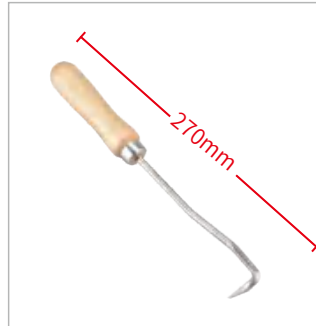

CL06  
Material:SUS201  
CTN:200PCS

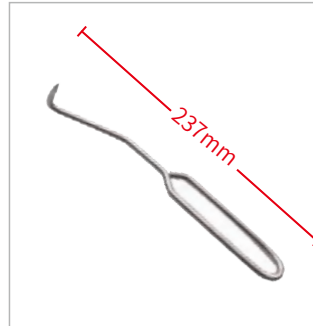

CL06-2  
Material:SUS201  
CTN:250PCS



CL07  
Material:SUS304  
CTN:1300PCS



CL08  
Material:PP  
CTN:1500PCS

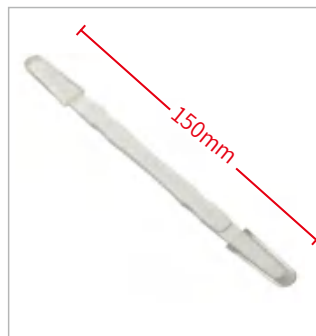

CL08-2  
Material:Plastic  
CTN:1500PCS



CL08-3  
Material:Bamboo  
CTN:1200PCS



CL08-4  
Material:Plastic  
CTN:100PCS

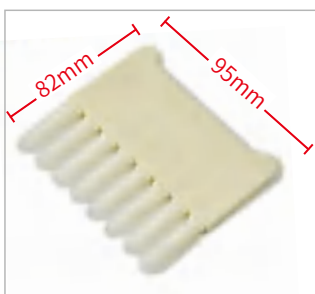

CL08-5  
Material: PP/food grade  
CTN:200PCS

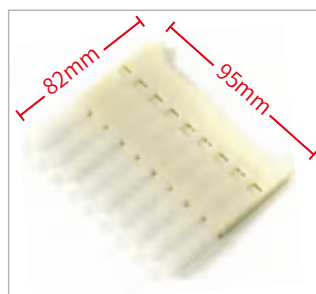

CL08-6  
Material: PP/food grade  
CTN:200PCS



CL09  
Material: PP  
CTN:100PCS

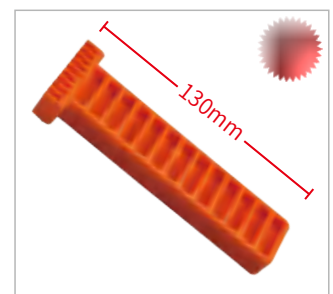

CL10  
Material:PP  
CTN:300PCS





# Cleaning tools



OEM/ODM available >>

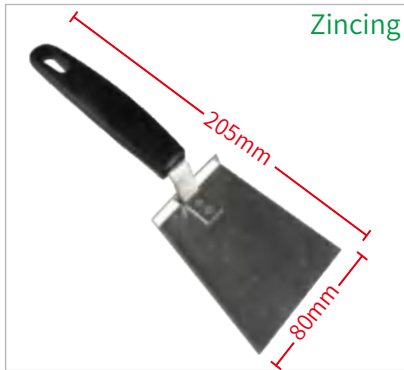

**CL01**  
Material:Galvanized  
CTN:180PCS



**CL01-2**  
Material:SUS430  
CTN:200PCS

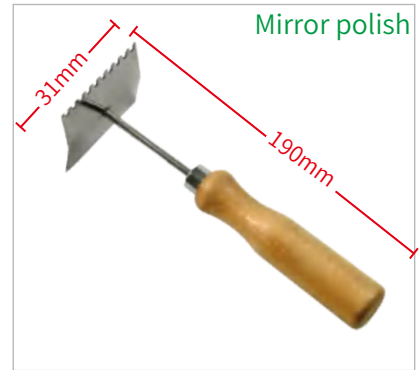

**CL02**  
Material:SUS430  
CTN:120PCS

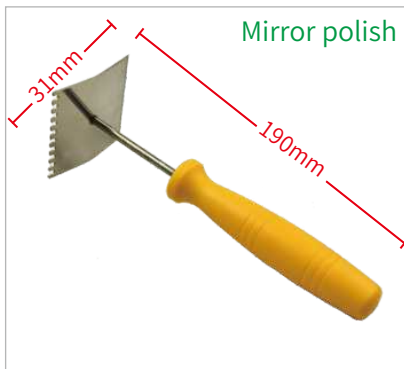

**CL02-3**  
Material:PP & SUS430  
CTN:120PCS

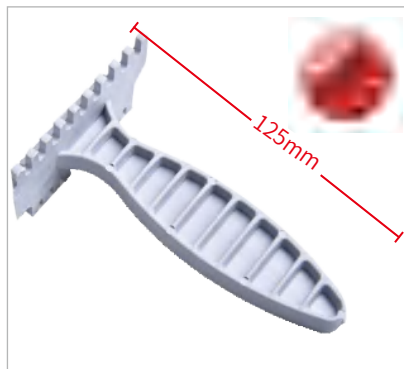

**CL02-4**  
Material:Plastic  
CTN:500 PCS

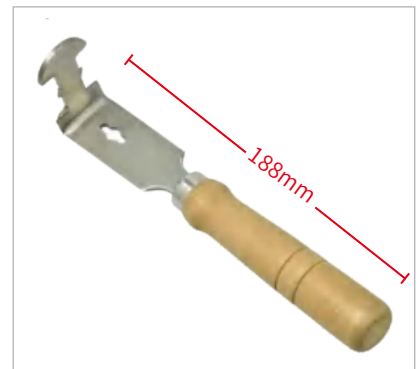

**CL03**  
Material:Galvanized  
CTN:200PCS

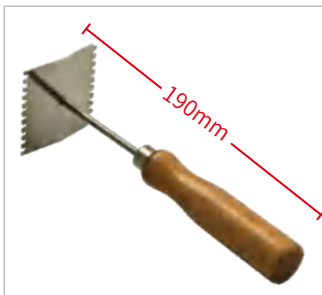

**CL02-2**  
Material:SUS304  
CTN:176PCS



**CL09-2**  
Material: silicone spatula  
CTN:100PCS



**CL04**  
Material:SUS201  
CTN:100PCS

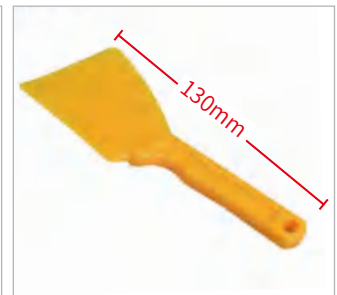

**CL09-3**  
Weight: 64g  
CTN:250PCS



# Bee brush

 Benefitbee®

OEM/ODM available >>

## Model:BR02

BB Bee brushes(Single row plastic)  
Material: Plastic

CTN:100 PCS

◆ **Patented product**

Patent No.:201930551034. 3



## Model: BR07

Bee brushes(single rows horsehair)  
Material: Plastic&horsehair

CTN:600 PCS



## Model: BR06

Bee brushes(Double rows horsehair)  
Material: Pine&horsehair

CTN:500 PCS



## Model: BR05

Bee brushes(Double rows bristles)  
Material: Bristles&pine

CTN:500 PCS



## Model: BR04

Bee brushes(Four rows horsehair)  
Material: :Horsehair&pine

CTN:250 PCS



# Bee brush



OEM/ODM available >>



CTN:1 PCS

**Model: BR08**

Electric bee taking-off machine  
Rated power:150W,Voltage:12V



Handle:450mm  
Brush width:7cm

**Model : BR11**

BB Bee brushes(Double rows bristles)

CTN:200 PCS



**Model:RB01**

Double rows horsehair bee brush  
Material:Pine&Horsehair

CTN:150 PCS



**Model:BR03**

Single row plastic bee brush  
Material: varnished beech + plastic brush

CTN:200 PCS



**Model : BR09**

Bee brushes(Three rows bristles)  
Material:Bristles&Pine

CTN:320 PCS



**Model : BR10**

Bee brushes(Three rows plastic)  
Material:Plastic&Pine

CTN:320 PCS





# Bee gloves

**Benefitbee**®

Material,color,size,style can be customized

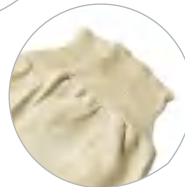

## Model: BG07

### Beekeeping glove

Material:White sheepskin +Polyester cotton  
Size:L,XL,XXL

CTN:200PCS

## Model: BG03

### Beekeeping ventilated glove

Material:Golden sheepskin +  
High breathable mesh+  
Polyester cotton  
Size:L,XL,XXL  
Colour:yellow、 white

CTN:200PCS

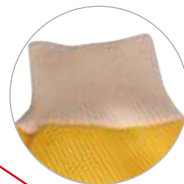

## Model: BG11

### Bee gloves(Euro Grade A sheepskin)

Material: Yellow sheepskin +  
TC breathable mesh  
size :S-XXXL

CTN:200PCS



# Bee gloves

Benefitbee®

Material,color,size,style can be customized

## Model: BG08

### Bee gloves (Euro,Grade A sheepskin)

Size:L,XL,XXL

Material:White sheepskin + Polyester cotton

CTN:200PCS



White sheepskin + High breathable mesh+Polyester

### BG04

Size:L,XL,XXL



Golden sheepskin + High breathable mesh+Canvas

### BG05

Size:L,XL,XXL



White sheepskin +Polyester cotton

### BG09

Size:L,XL,XXL



Golden sheepskin & + Polyester cotton

### BG01PG

Size:L,XL,XXL



Golden sheepskin & Canvas

### BG01CG

Size:L,XL,XXL



White sheepskin & Canvas

### BG01CW

Size:L,XL,XXL



White sheepskin & Canvas

### BG12

Size:S,M,L,XL,XXL



White sheepskin & Polyester cotton

### BG01PW

Size:L,XL,XXL



White sheepskin & Polyester cotton or canvas

### BG02

Size:L,XL,XXL



three - layer breathable mesh cloth and sheepskin

### BG06

Size:L,XL,XXL



PVC+ beef tendon sole

### BG10

Size 39-45



# Bee suits

Material,color,size,style can be customized

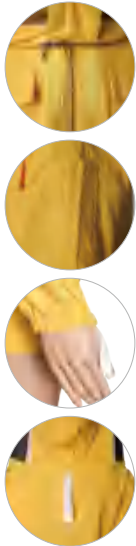

## Model:BS16-2

Bee jacket

Material: 100% cotton

gr/m<sup>2</sup>: 150g

CTN:25PCS

Color :

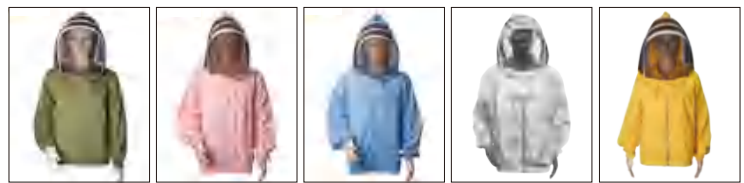

## Model:BS16

Bee jacket

Material: 100% cotton

gr/m<sup>2</sup>: 150g

Color:



## Model:BS17

European style half-length round hat bee jacket (without zipper)

## Model:BS19

European style bee pants

Color:







# Bee suits



Material,color,size,style can be customized



### Model:BS18

European astronaut hat overall beesuit

Material: 100% cotton

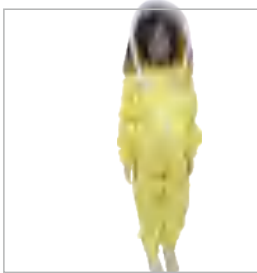

BS01-S



BS01



BS01-2



BS04



BS09



BS05



BS08



BS14



BS14-2



BS14-3



# Bee suits



Material,color,size,style can be customized



BS06



BS07



BS10



BS11



BS12



BS09-2



BS13



BS15

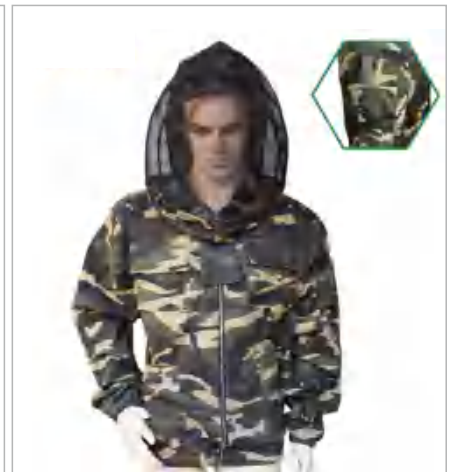

BS16-3



# Bee hats



Material,color,size,style can be customized

Model: BH06



Model: BH07

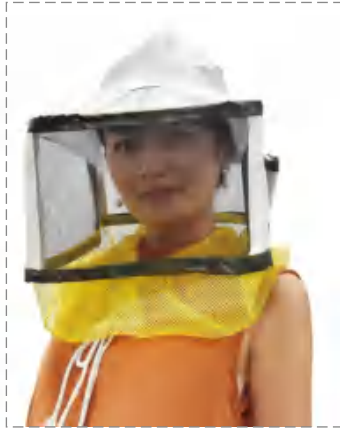

Model: BH02



BH01



BH01-2



BH09



BH04

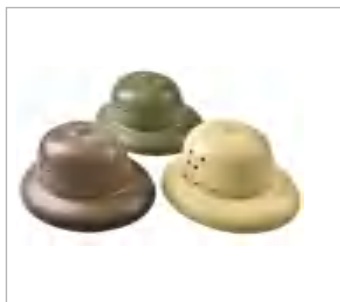

BH04-2



BH05



BH08



BH03



BH10



BH11





# Queen cages



**Model: QC41**

Wasp trap for plastic bottle



**Model: QC49**

Queen catcher



**Model: QC51**

Queen catcher



**Model: QC44-2**

JZBZ queen bee protection box



**QC37-3**  
Queen control box  
(2FRAME)



**QC39**  
Queen catcher



**QC42**  
Swarm catcher(Euro)



**QC43**  
Marking cages



**QC44**  
JZBZ queen bee protection box



**QC45**  
Marking cages



**QC50**  
Queen catcher



**QC52**  
Queen catcher



# Queen cages



**Model: QC29**

Wasp trap (Rotatable)



**Model: QC32**

Wasp trap (Large)

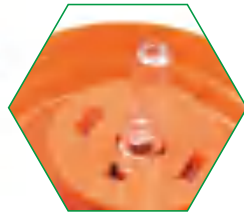

**Model: QC31**

Wasp trap (Solar LED light)



**Model: QC30**

Wasp trap (Gourd shaped)



**QC35**

Queen cages



**QC36**

Bee collecting cage



**QC36-2**

Bee collecting cage



**QC37**

Queen control box (1FRAME)



**QC37-2**

Queen control box (2FRAMES)



**QC46**

Skep straw hive(3PCS)



# Queen cages



QC01



QC02



QC02-2



QC03



QC04



QC05



QC06



QC07



QC08



QC09



QC09-2



QC11



QC12



QC13



QC14



QC15



QC16



QC17



QC18



QC19



QC20



QC21



QC21-2



QC23



QC24



QC25



QC40



QC26



QC27



QC28



QC33

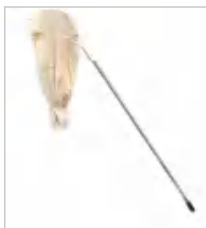

QC34





### Model:QB43

**BB Queen incubator**  
Input voltage: DC 12v  
Heating temperature: 36 °C  
Can put cell cup: 54pcs

**Patented product**

Patent No.: 202220476207.6

### Model:QB01-9

**Grafting tool**  
tip diameter:0.5mm  
Weight:35g  
Material:SUS420

**Patented product**

Patent No.:ZL 2022 3 0510174.8

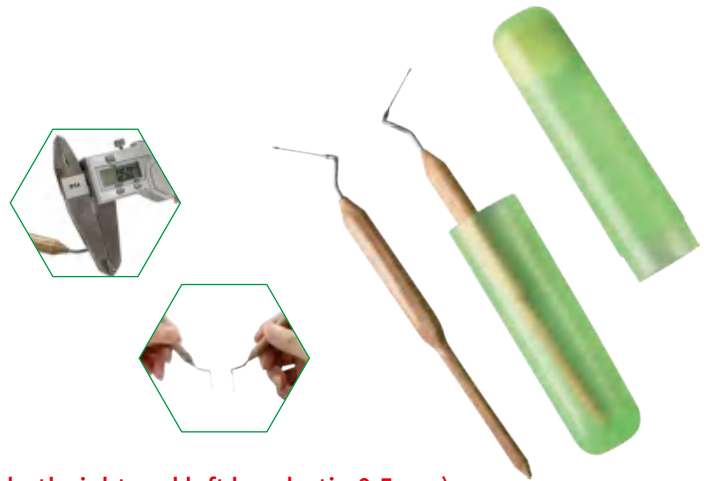

(fit for both right and left hands, tip 0.5mm)

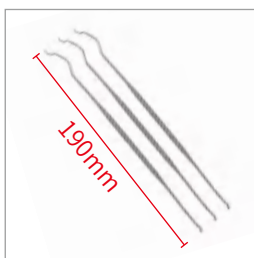

QB01-8  
Grafting tool



QB02-4  
Head band magnifier  
(not included battery)



QB04-7B  
Queen cell bar

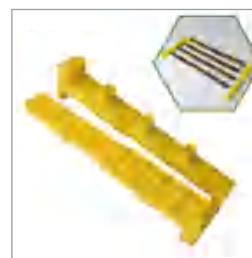

QB04-7C  
JJBZ Plastic Royal  
Jelly Frame



QB04-9  
Holder for queen cell



QB04-12  
Queen rearing box



QB38  
Cell cup silicone  
mould



QB38-2  
Cell cup silicone  
mould

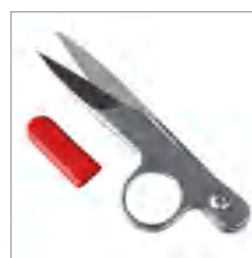

QB39  
Scissor

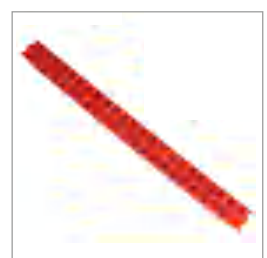

QB42  
Queen shipper



# Queen breed tools

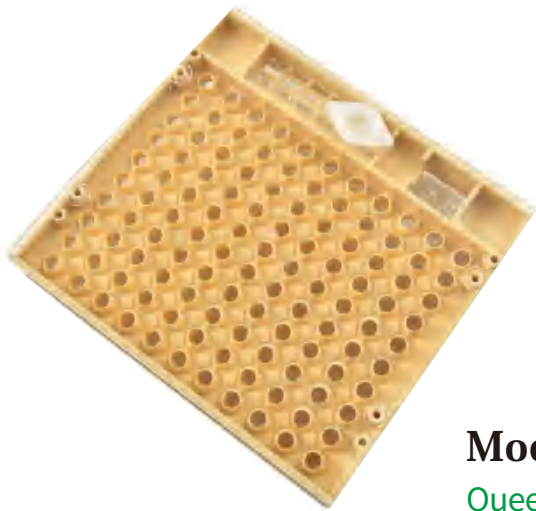

**Model: QB04**  
Queen rearing box



**Model: QB04-2**  
Queen cell

1. Insert the comb box into a frame and 110 brown cell starter cups are fitted into the back of it.  
(With this kit you will be able to raise your own queens and do it without grafting or ever touching a larvae.)
2. Confine the queen in the front of cage and she immediately lays eggs in the 110 available cells.  
She can be released in the next day. On the 4th day each newly hatched larvae is ready for transfer.
3. Remove each cell starter cup and insert it into a cell cup holder.
4. Slid this unit onto a cell bar holder which is attached to a cell bar.
5. To finish the cells you now put the cell bar into a cell building colony.

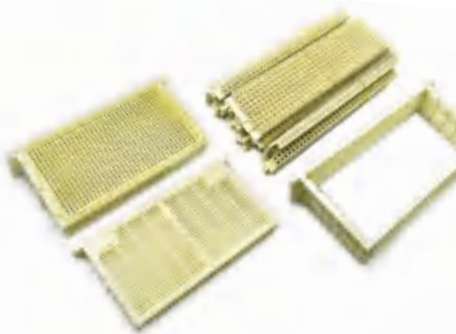

**Model: QB06**  
No graft queen rearing system  
for mellifera bees



**Model: QB07**  
Queen marking pen



**Model: QB08**  
Queen marking pen (1 PCS)



**Model: QB06-2**  
Mellifera royal jelly frame

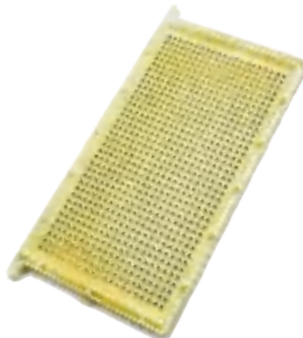

**Model: QB06-3**  
Impregnated Mellifera larva  
breeding frame



**Model: QB06-5**  
No graft queen rearing system  
for mellifera bees



# Queen breed tools

Benefitbee®

Material,color,size,style can be customized



## Model: QB03

### Grafting support

Grafting support can ascend and descend to adjust people's sitting position so as to relieve the user's injuries of cervical vertebra and lumbar vertebra; it is flexible,portable, compact , which does not occupy too much space.



## Model: QB01-6

### Plastic grafting tool

100% new and service to the beekeeper  
Material: Plastic Black color  
Total length: Approx 12 cm

2 graft tools in one box  
Threading Needle: 113mm \* 6mm  
Packing box: 118mm \* 30mm

## Model: QB02-3

### Desktop loupe



QB01  
Aluminium handle grafting tool

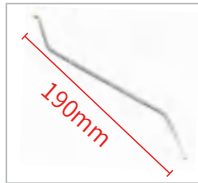

QB01-2  
Stainless steel grafting tool

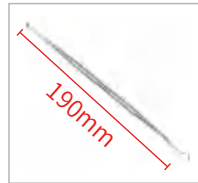

QB01-3  
Stainless steel grafting tool (European style)

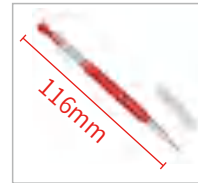

QB01-4  
Plastic grafting tool Horn

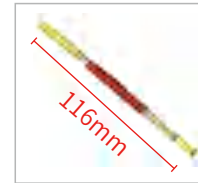

QB01-5  
Plastic grafting tool Horn



QB01-7  
American style plastic grafting tool



QB02  
Binocular head loupe



QB02-2  
Binocular head loupe



QB04-3  
Queen cell cup



QB04-4  
Plastic frame spacer



QB04-5  
Queen cell cup (The larva not longer need to be transferred)

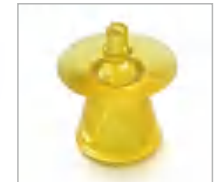

QB04-6  
JZ BZ base mount



QB04-7  
JZ BZ base mount cell cups



QB04-8  
Push-In Cell Cups

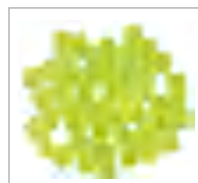

QB04-10  
Queen cell



QB05  
Birth control tweezer



QB06-4  
Mellifera adjustable bottom row



QB06-6  
Mellifera impregnation queen stripe





# Other products



## Model: J31 (1.5L)

Honey heating pot  
(Customizable 1L/2L/2.5L/3L)

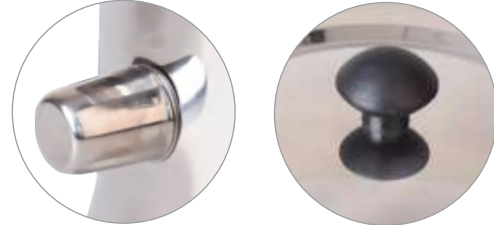

## Model: QT68

Bee venom acquisition instrument



## Model: J32

Honey heating pot

Material: SUS304  
100X210X125mm



QT74

Thermo&humidity  
meter



QT74-2

Digital thermometer



QT77

Liquid Propolis Scale  
Dispenser



QT78

Liquid Propolis Scale  
Dispenser



OT02

18 function combined  
knife card



OT04-3

Monitor solar power



OT04

Outdoor beehive  
burglar monitor



OT04-2

Outdoor beehive  
burglar monitor



# Other products



**Model: QT60**  
Honey dispenser Jar



**Model: QT85**  
Beeswax cube silicone mold

## Tool box/tool set box>>



QT69X2-AB  
dual layers



QT69X3-ABC  
3 layers



QT69X3-ABD  
3 layers



QT69X4-ABCD  
4 layers with cover



QT69X4-ABCE  
4 layers with cover



QT010  
Honey dipper

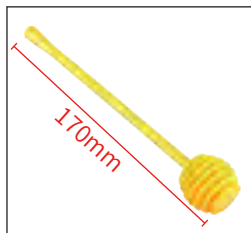

QT010-2  
Honey dipper  
(plastic)

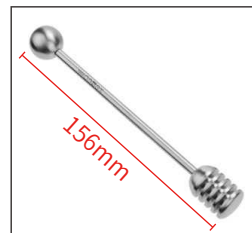

QT010-3  
Honey dipper  
(SUS304)

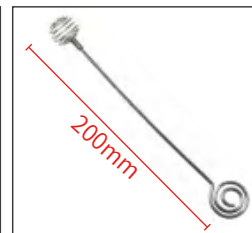

QT010-4  
Honey dipper  
(SUS304)

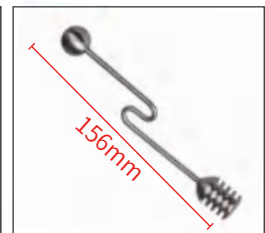

QT010-5  
Honey dipper  
(SUS304)

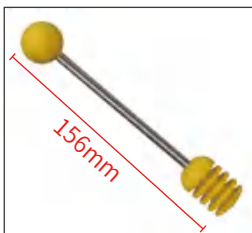

QT010-6  
Honey dipper  
(SUS304)

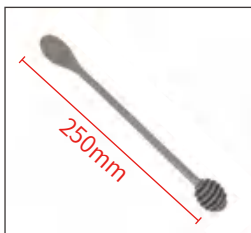

QT010-7  
Dual-purpose  
honey dipper



QT41-4  
Digital honey  
refractometer

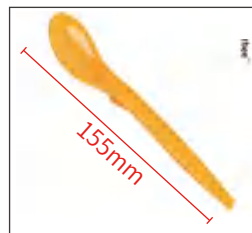

QT58  
Plastic honey spoon



QT80  
Honey jar linen bag



QT41  
Honey refractometer  
tester



QT41-3  
Digital honey  
refractometer (new style)



QT45  
Hand labeler



OT03  
Sprayer



QT81  
Plastic-coated  
pushpin



# Pest control tools

Benefitbee®

## Model:PC09-3

BB Oxalic acid heater(simple version)  
Voltage: 110V-230V  
Power: 250W  
Maximum temperature: 280°C  
CTN:10PCS

### ◆ Patented product

Appearance Patent No. :202030435142.7  
Utility Model Patent No. :202120820132.4

## Product upgrade



### PC09-2

CTN: 10PCS  
Voltage:110-230V  
Power: 250W  
Temperature setting:280°C



### PC17-2

CTN: 1PCS



### PC18

CTN: 20PCS  
Voltage:12V

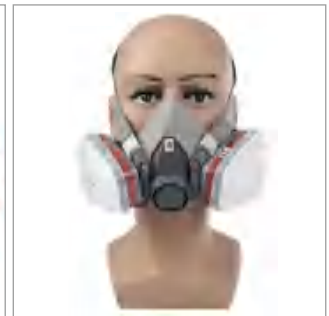

### PC28

CTN: 32 set  
Size :16.5cm x11.2cm x13cm



### PC17

CTN: 1PCS



### PC14

CTN:300PCS



### PC15

CTN:1000PCS



### PC16

Material: PP  
CTN:50PCS





# Pest control tools



## Model: PC01

Mite medicine atomizer

Handle: wooden

Material: stainless steel & aluminum

Voltage: 12 V

Temperature : 160°-190°

CTN: 30PCS

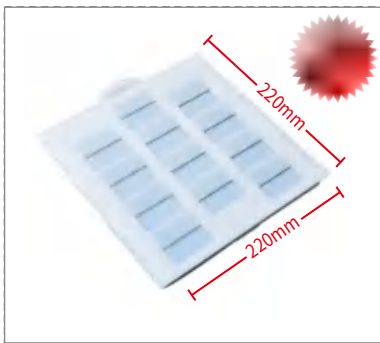

PC02  
Material: pp+Plastic  
CTN: 60PCS



PC04  
Weight: 3.9KG  
CTN: 1PCS

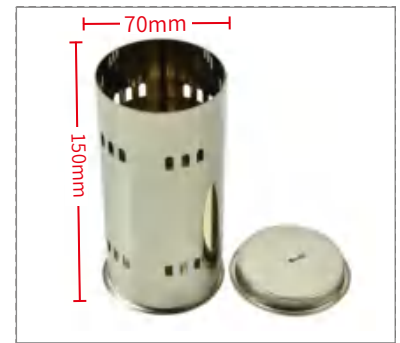

PC05  
Material: SUS304  
CTN: 60PCS



PC06  
Material: PP  
CTN: 800PCS

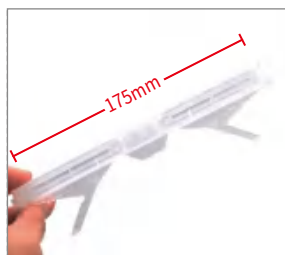

PC07  
Material: PP  
CTN: 1400PCS

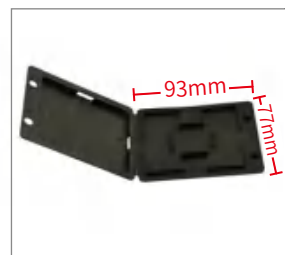

PC08  
Material: PP  
CTN: 500PCS



PC09  
Voltage: 12V  
CTN: 50PCS



PC10  
Material: PP+foam  
CTN: 250PCS

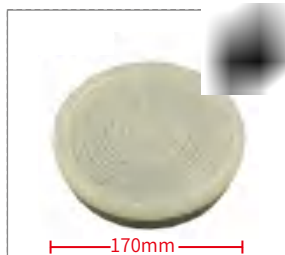

PC11  
Material: PP  
CTN: 100PCS

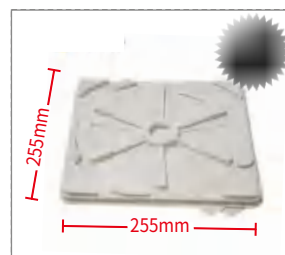

PC12  
Material: PP  
CTN: 80PCS



PC13  
CTN: 25PCS



# Bee medicines



**BM22**  
Varroa mite-killer



**BM22-1**  
Varroa mite-killer



**BM22-2**  
Varroa mite-killer



**BM22-3**  
Bee mite killer (Flumethrin strip)



**BM22-4**  
Bee mite killer



**BM25-1**  
Golden mite-killer



**BM25-2**  
Golden mite-killer



**BM26**  
Prosperous mite-killer



**BM41**  
Amitraz aerosol (Zhenxing)



**BM42**  
Formic acid aerosol (Zhenxing)



**BM43**  
Varroa mite-killer (10//20pcs)



**BM55**  
Bee bait (60ml)



# Bee medicines



**BM45**  
Fluvalinate Strips  
10 /20strips



**BM46**  
Fluvalinate Strips  
10/20 strips/bag



**BM47**  
MANPULIKE  
10/20 strips/bag



**BM48**  
Manjing - Flumethrin Strips  
10/20 strips/bag



**BM49**  
Mavrilk - Fluvalinate Strips  
20 /40\*2 strips/bag



**BM51**  
Man Jie - Formic Acid Aerosol



**BM52**  
Miticide - Amitraz  
Solution Aerosol



**BM53**  
Bee liquid (100ml)



**BM54**  
Bee trap lure (30ml)





# Bee wax



## Model: BW01

Beeswax grade D ●

Pure beeswax content: 30%



## Model: BW02

Beeswax grade C ●

Pure beeswax content: 50%



## Model: BW03

Beeswax grade B ●

Pure beeswax content: 80%



## Model: BW04

Beeswax grade A ●

Pure beeswax content: 100%



Hydrocarbon	16%-18%
Melting point	62-87 °
Acid value	16%-23%
Saponification value	75%-110%
Impurity	<0.1%
Packing	20kg/bag

**Model: BW05 Pure beeswax**



**Model: HF04**

Canola pollen  
Sunflower pollen  
Buckwheat pollen



HF02  
Canola pollen



HF05  
Sunflower pollen





# Honey tank

Benefitbee®

## Customizable specifications

### Model:HD70/HD90

Decrystallization honey tank

HD70 70L 52X52X77CM

HD90 90L 52X52X83CM



### Model : HAP06

Honey melting blanket

Size:103\*31cm

Electric:80-220V

Average power:160W

NW:1.5KG

GW:2KG

one pc/box

HS: 6301300000





# Honey tank

Benefitbee®

## Customizable specifications



### Model:HB025-A

Material:SUS201,Honey volume: 20L,  
Bucket body thickness:0.8MM,Diameter:30cm,Height:30cm  
Processing technology:Seamless welding &polishing,  
(Not including honey gate)

HB25-A	25KG-30X30CM
HB50-A	50KG-35X40CM
HB75-A	75KG-40X45CM
HB100-A	100KG-45X50CM
HB150-A	150KG-50X58CM
HB200-A	200KG-60X55CM



### Model:HB025-B

Material:SUS201,Honey volume:20L,  
Bucket body thickness:0.8MM  
Diameter:30cm,Height:30cm  
Processing technology:Seamless welding &polishing,  
(Not including honey gate)

HB25-B	25KG-30X30CM
HB 50-B	50KG-35X40CM
HB 75-B	75KG-40X45CM
HB100-B	100KG-45X50CM
HB150-B	150KG-50X58CM



### Model: TW70-A

Thermo regulatd decrystallization  
honey tank (201 steel flat lid)



### Model:HC30/50/70/80/120-201

Honey tank with double-layer filter

HC30-201	30L-37X35CM
HC50-201	50L-37X47CM
HC70-201	70L-37X65CM
HC80-201	80L-37X74CM
HC120-201	120L-47X74CM(No filter)



# Honey tank

Benefitbee®

Customizable specifications



### Model: HB25-C

Material:SUS201,Honey volume:20L,  
Bucket body thickness:0.8MM  
Diameter:30cm,Height:30cm  
Processing technology:Seamless welding &polishing,  
(Not including honey gate)

- HB25-C 25KG 30X30CM
- HB50-C 50KG 35X40CM
- HB75-C 75KG 40X45CM
- HB100-C 100KG 45X50CM
- HB150-C 150KG 50X58CM
- HB200-C 200KG 60X55CM



### Model: TW70-B

Thermo regulated decrystallization  
honey tank(304 stainless steel honey gate)  
Material:SUS201  
Honey volume: 70L



### Model: HAP05

Honey tank stand  
Diameter 32cm  
Height 35cm  
Material: 201 T=2.0mm single side wire drawing



# Honey pail



## Customizable specifications



**HA3/4/5/6/15/18/20L-A**

3/4/5/6/15/18/20 liters plastic honey pail (zipper lid)



**HA6/20/25L-B**

6/20/25 liters plastic honey pail (thickened body)



**HA3/6/18/20L-C**

3/6/18/20 liters plastic honey pail (America style)



**HAP04-30/35/40/45/50/52**

Stainless steel bracket for honey barrel (H50cm,  $\Phi$ 30/35/40/45/50/52cm)



**HAP09-1**

Metal drum heater



**HAP09-2**

Silicone heating pad

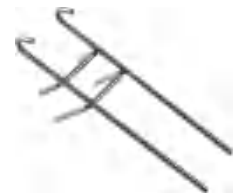

**HPA02-2**

Honey tank support



**HAP07**

Honey Mixer



**HAP07-2**

Honey Mixer



**HAP07-3**

Honey Mixer

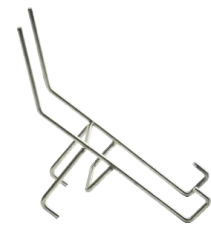

**HAP02**

Honey tank support



**HAP08**

Honey straining heater



**HAP01**

Pail opener



**HAP02-3**

Honey Pail Support

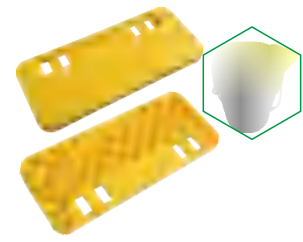

**HAP03**

Plastic frame scraper





# Honey gates



OEM/ODM available >>

 ABS OD45mm	 Nylon OD44.5mm	 ABS OD48mm	 SS304 OD48mm
HG04	HG08	HG09	HG11
 ABS OD45mm	 ABS OD45mm	 ABS OD45mm	 ABS OD48mm
HG01W	HG01G	HG01R	HG10
 ABS OD45mm	 ABS OD45mm	 Nylon OD45mm	 Nylon OD48mm
HG01Y	HG01O	HG02	HG03
 SS304 OD45mm	 SS304 OD45mm	 PP OD45mm	 SS304
HG07	HG06	HG05	HG12



# Wax press



OEM/ODM available >>



**Model: ZT05**

Stainless steel wax press



**ZT04** (Stainless steel)



**ZT03** (Iron)



**ZS03** (Stainless steel)



**ZT01-B** (Iron)



**ZS01** (Stainless steel)



**ZT01** (Iron)



**ZS02** (Stainless steel)



**ZT02** (Iron)



**ZT01-2** (Iron)



**ZT01-B2** (Iron)



**ZT02-2** (Iron)



**ZS01-2** (Stainless steel)



**ZS02-2** (Stainless steel)



# Beeswax foundation roller



OEM/ODM available >>



## Model: FM01

Fully automatic beeswax machine

## Model: FM04

Beeswax embossing machine  
The size of the machine or cell  
Size can be customized.

## Model: FM06

Comb silicone mold



FM02-1 86X195mm



FM02-1D 86X195mm



FM02-2 86X250mm



FM02-2D 86X250mm



FM02-3 86X310mm

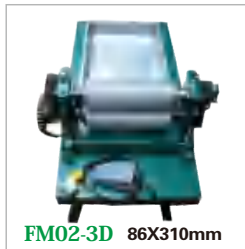

FM02-3D 86X310mm



FM02-4D 86X450mm



FM03-1 86X310mm



FM03-2 86X350mm



FM03-3 86X500mm



FM03-4 170X350mm



FM03-5 170X500mm



FM03-6 86X450mm



FM05-1 75X310mm



FM05-1D 75X310mm



FM05-2 75X350mm



FM05-2D 75X350mm



FM05-3 75X500mm



FM05-3D 75X500mm

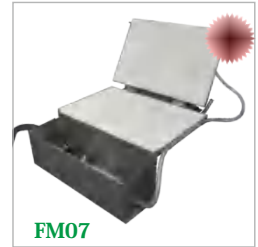

FM07



FM08 44x22cm



FM09



FM09-2

● Cell size or roller size can be customized





## Model: ME01

Insemination equipment



## Model: ME01-3

Insemination equipment microscope



Beekeeping tools Benefitbee efficient coupling equipment professional microscope  
Instrument queen bee artificial Insemination kits



### ME01-2

Insemination equipment  
(Anesthesia bottle)



### MEP04

Insemination equipment



### MEP05

Insemination equipment  
microscope



### ME39

Honey filling machine



### ME16

Pollen dryer



### ME22

Honey and wax  
separating machine



### ME26

Frame support with  
filter tank



## Model:ME39-3

### Honey filling machine

Rated voltage: DC12V AC110V AC220V  
 Rated powder: 120W  
 Item size:567mm \* 322mm \* 282mm  
 Applicable capacity: 100g-5000g  
 Flow rate: 500g 470 bottle/H  
 Filling error: 1g  
 Filling height: 0-380mm  
 Applicable viscosity: Below 44 Baume degree  
 Filling environment temperature: Above 5°C  
 Applicable liquid temperature: 5-90°C  
 Filter density: 150um  
 Filtration flow: 500L/H



**ME39-2**  
Honey filling machine



**ME39-6**  
Honey filter



**ME39-7**  
Honey filling machine  
(copper pump)



**ME39-8**  
Honey filling machine  
(304 stainless steel pump)



**ME20**  
Automatic spleen-cutter



**ME24**  
Hand push type honey  
pumping & shaking



**ME40**  
Handheld branding  
machine



**ME27**  
Solar melting beewax machine



**ME38**  
Semi-automatic cutting  
machine



**ME41**  
Pollen dryer

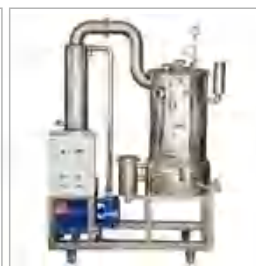

**ME03**  
0.5 ton original flavor  
reflux concentrator



**ME03-B**  
1 ton original flavor  
reflux concentrator



**ME44**  
Beehive Frame  
Making Machine



# Candle silicone molds



## Model : RS1-1006

### Candle silicone mold

Mould Size: 5.5cmX8cm  
 Mould Weight: 130g  
 Product Size: 4.5X7.5cm  
 Product Weight: 88g



RS1-1020

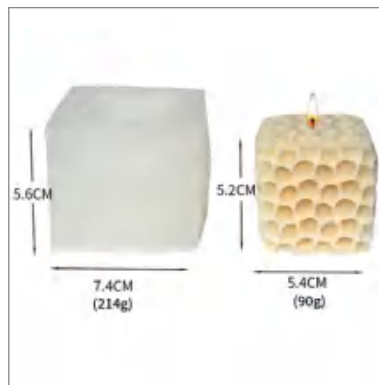

RS1-1034



RS1-1035



RS1-1036



RS1-1070

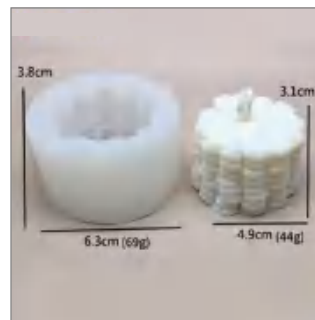

RS1-1071

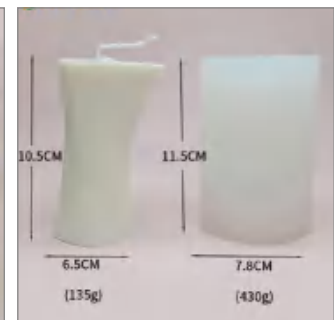

RS1-1157



RS1-1158

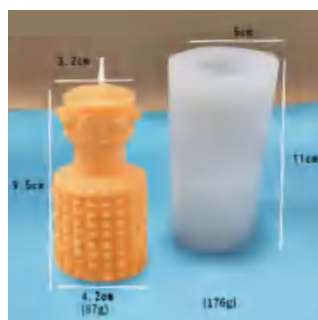

RS1-1161

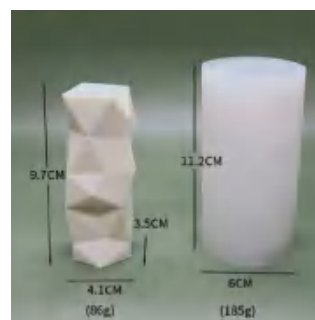

RS1-1162

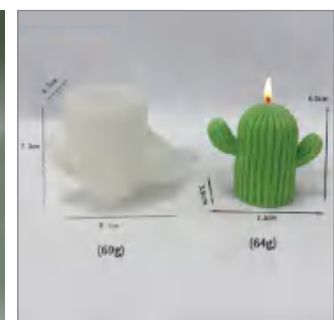

RS1-1164





# Candle silicone molds



RS1-1165

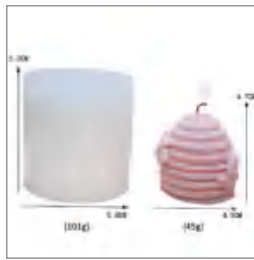

RS1-1167

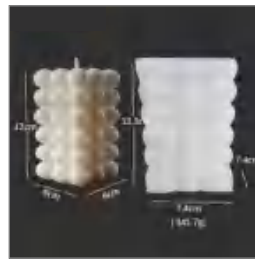

RS1-1169



RS1-1171



RS1-1249



RS1-1282

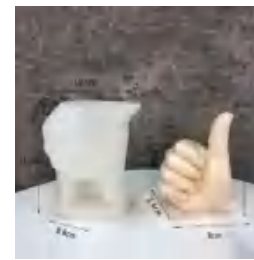

RS1-1702



RS1-458



RS1-459

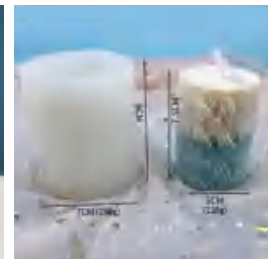

RS1-891



RS1-930

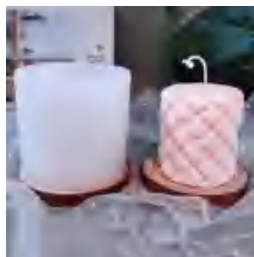

RS1-973

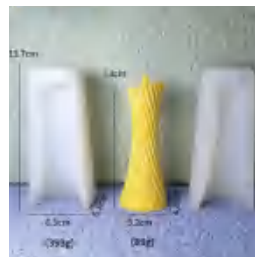

RS1-989



RS1-994



SR1-1513



SR1-1514



SR1-1701



SR1-1702

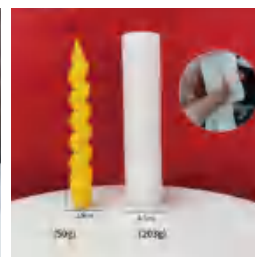

SR1-1720



SR1-1721

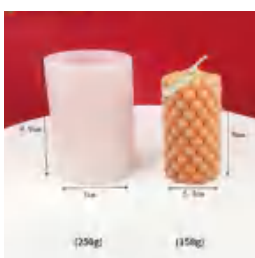

SR1-1770



SR1-2007



SR1-2011

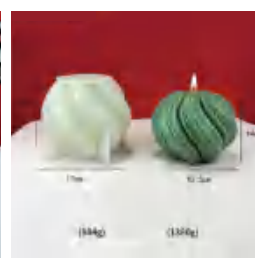

SR1-2039



SR1-2040



# Candle silicone molds

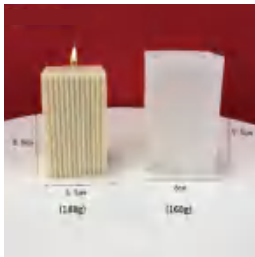

SR1-2043

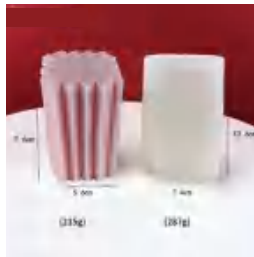

SR1-2044



SR1-2045



SR1-2046



SR1-2197



SR1-2262



SR1-2272



SR1-2273



SR1-2274



SR1-2275

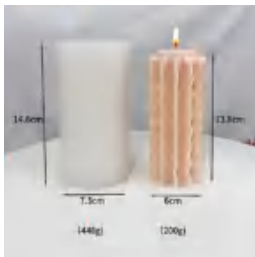

SR1-2295



SR1-2459

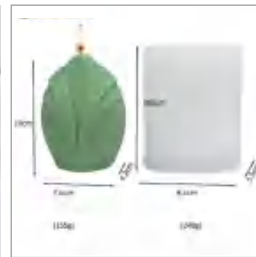

SR1-2501



SR1-2502



SR1-2503



SR1-2504



SR1-2529



SR1-2540



SR1-2639



SR1-2640



SR1-2641

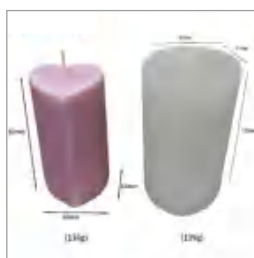

SR1-2642

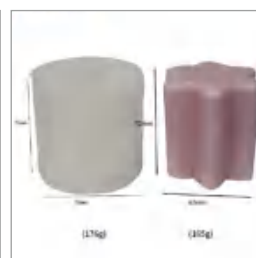

SR1-2643



# Beeswax silicone moulds



**SIL001**  
Flower heart-shaped  
silicone mold



**SIL002**  
Face cylindrical  
silicone mold



**SIL003**  
Flowery cylindrical  
silicone mold



**SIL004**  
Hexagonal silicone mold



**SIL005**  
Owl oval silicone mold



**SIL006**  
Butterfly square  
silicone mold



**SIL007**  
Cylindrical silicone mould



**SIL008**  
Flower cylindrical  
silicone mold



**SIL009**  
Mermaid square  
silicone mold



**SIL010**  
Flower fairy square  
silicone mold



**SIL011**  
Honey bee hexagonal  
honeycomb silicone mold



**SIL012**  
Three flower heart-shaped  
silicone mold





# beeswax candle



Beeswax content: 40%

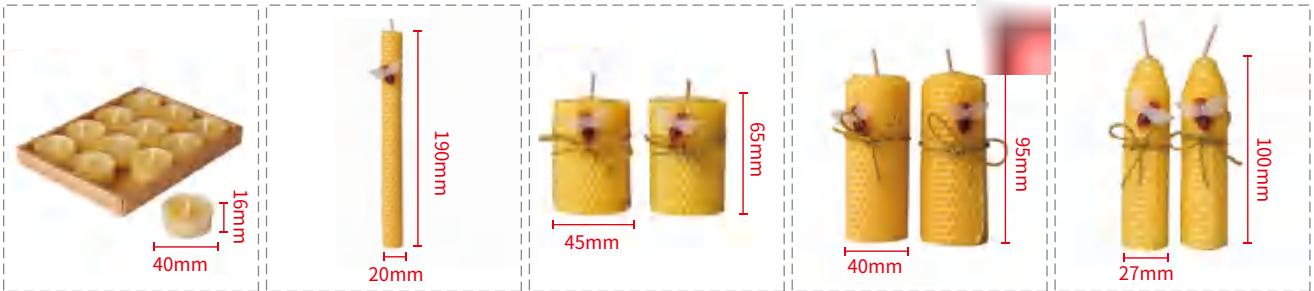

BC001  
Weight: 220g

BC002  
Weight: 64g

BC003  
Weight: 115g

BC004  
Weight: 118g

BC005  
Weight: 64g

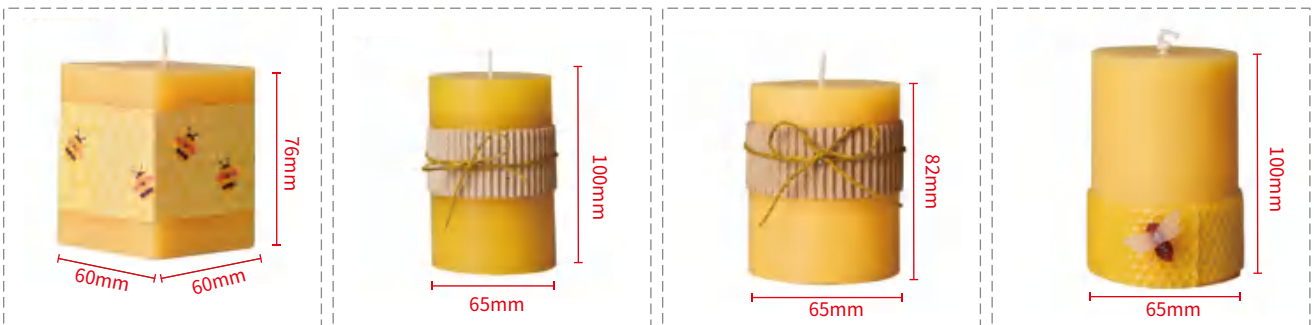

BC006  
Weight: 250g

BC007  
Weight: 315g

BC008  
Weight: 268g

BC009  
Weight: 321g

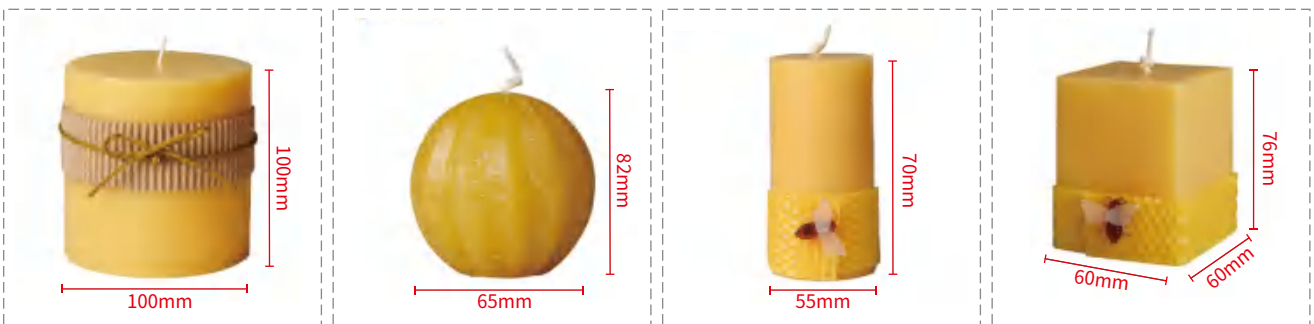

BC010  
Weight: 725g

BC011  
Weight: 122g

BC012  
Weight: 118g

BC013  
Weight: 252g

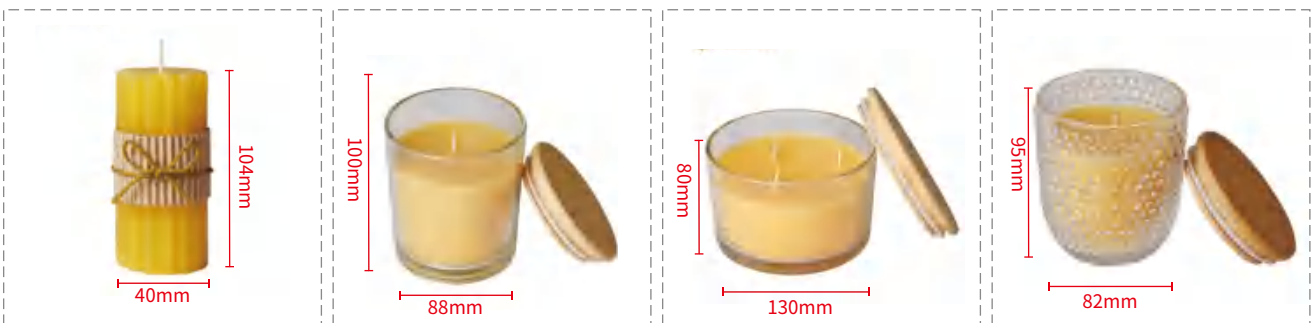

BC014  
Weight: 158g

BC015  
Weight: 625g

BC016  
Weight: 984g

BC017  
Weight: 525g



# Resin crafts



**Model : RC005**

BB Resin craftwork

Material: Resin product  
Size: 5\*11cm (width \* height)  
Product weight; 108g

◆ **Patented product**

Patent No.:202030688284.4

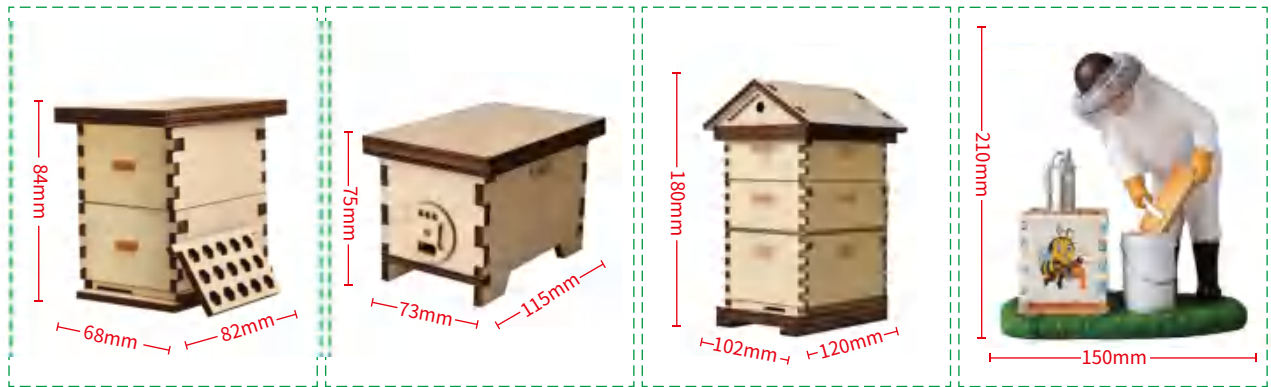

RC006

RC007

RC008

RC001-1



RC001-2

RC001-3

RC001-4

RC001-5



RC001-6

RC002

RC003

RC004



# Honey bottle



## Honey glass jar

Model	G09-1	G09-2	G09-3
Diameter	52mm	65mm	75mm
Height	85mm	100mm	120mm
Side	62mm	80mm	100mm
Capacity:	180ml	380ml	730ml



## honey glass bottle

Model	G13	G14
Caliber:	69.5mm	80mm
Height:	104mm	137mm
Weight:	200g	350g
Capacity:	380ml	770ml

## Boston Round Dropper bottle with plastic cap

Model	G12-2	
Capacity:	10ml	10ml
	15ml	20ml
	30ml	50ml
	100ml	







# Bee crafts



**BNC-001**  
Fortune bee



**BNC-002**  
LED smoker keychain  
44th apimondia  
Apiculture bronze medal for artistic exhibition



**BNC-003**  
Bee keychain



**BNC-004**  
Resign bee couple  
with storage bucket



**BNC-006**



**BNC-007**  
Motobike bee with clock  
Gold medal on 44th apimondia



**BNC-009**  
Bees lifting up honey



**BNC-011**  
Sweetbee



**BNC-012**  
Whole set Bottle holder



**BNC-013**  
Bee money container



**BNC-014**  
Umbrella with ears and a whistle



**BNC-015**  
Umbrella of bee and flower



**BNC-016**  
Bee pen holder



**BNC-017**  
Bee pen holder



**BNC-018**  
Trash can



**BNC-019**  
Trash can



**BNC-020**  
Guard bee

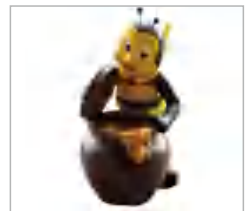

**BNC-021**  
Lawn music Box



**BNC-023**  
SD/USB music player

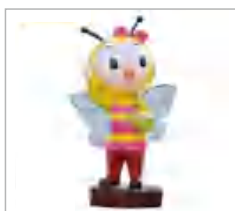

**BNC-024**  
Lovely bee

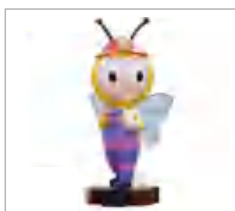

**BNC-025**  
Lovely bee

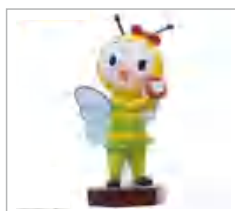

**BNC-026**  
Lovely bee

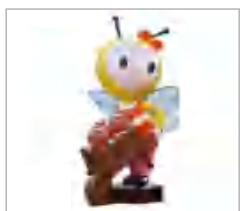

**BNC-027**  
Lovely bee



# Bee crafts

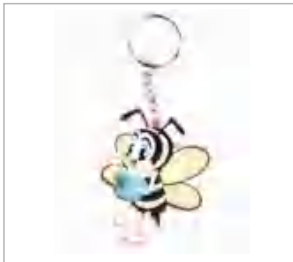

**BNC-027**  
Rubber bee with  
pot Keychain



**BNC-029**  
Simulation model bee



**BNC-038**  
Resin model simulation bee



**BNC-040**  
11 designs bee models

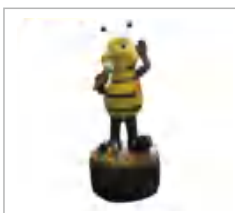

**BNC-042**  
Bee singer Loudspeaker



**BNC-045**  
Bee helicopter toy



**BNC-047**  
Cartoon bee costumes



**BNC-049**  
Solar Swing bee In the  
sunlight, leaves can swing

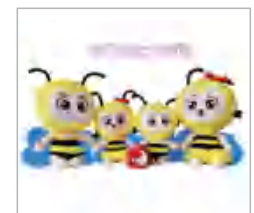

**BNC-051**  
Cartoon bee mascot



**BNC-052**  
Bee mascot keychain



**BNC-053**  
Electric simulation  
bee model

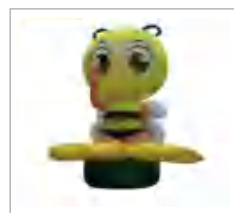

**BNC-056**  
Bee mascot inflatable gas  
model-Fengxiaobao

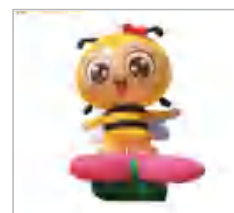

**BNC-057**  
Outdoor Large inflatable  
gas model -Fengxiaoya



**BNC-058**  
Bee mascot model

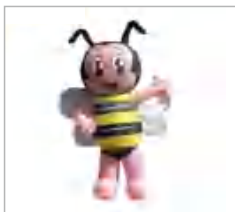

**BNC-059**  
Outdoor adversting  
inflatible bee gas model



**BNC-060**  
Barrel heater

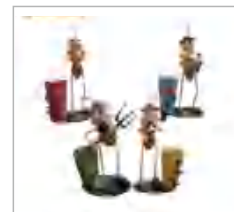

**BNC-066**  
Iron bee gardener



**BNC-068**  
Bee shape thermometer



**BNC-073**  
Bee anatomical model



**BNC-076**  
Bee development model



**BNC-077**  
Sweet Honeybee Carrier



**BNC-085**  
little bee backpack



**BNC-086**  
little bee notebook



**BNC-088**  
Children Ride On  
Motorcycle



# Bee broochs



AG009



AG015



AG041



AG050



AG062



AG080



AG091



AG130



AG132



AG134



AG149



AG152



AG158

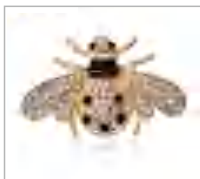

AG177



AG178



AG182



AG192



AG200



AG202



AG215



AG216



AL084



AL214



AL219



AL242

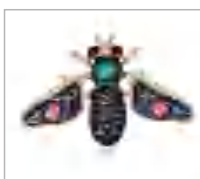

AL267



AL297



AL320

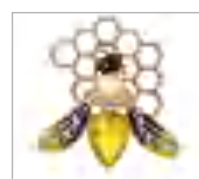

AL356

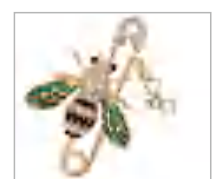

AL358





# Bee accessories



BS009



BSC002



BSC067



SCB043



SCB061



SCB104



SCC046



SCC410



SCC500



SCC654



SCC654



SCC821



SCC831



SCC870



SCC879

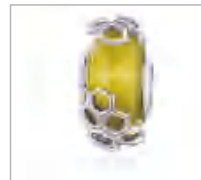

SCC1073

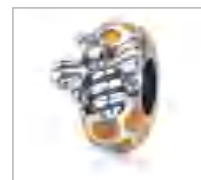

SCC1102



SCC1125

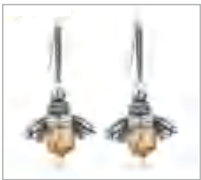

SCE149



SCE315



SCE344



SCE370



SCE484



SCN191



SCN202



SCN216



SCN221

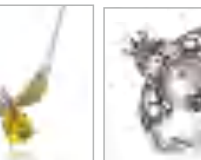

SCN242



SCR025



SCR086

SCR292

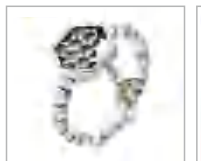

SCR329



SCR334



SCR348



SCR391



SCR422

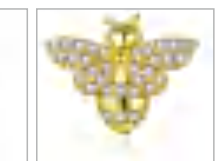

SCR433

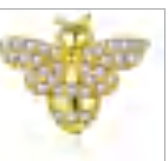

SCX103



# Bee 3D pictures

Benefitbee®



BP01



BP02



BP03



BP04



BP05



BP06



BP07



BP08



BP09

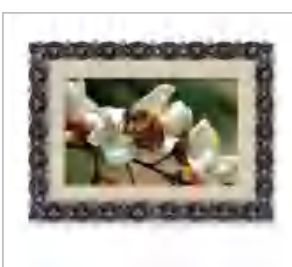

BP10

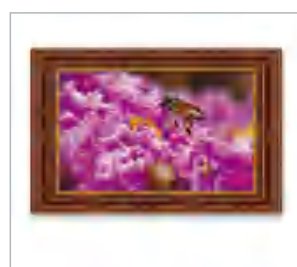

BP11



BP12

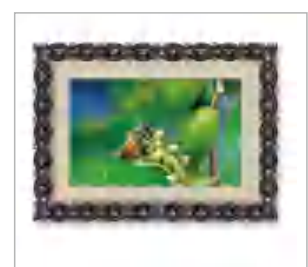

BP13





# Our office







# Our factory

Benefitbee®







# Our factory







# Our Beehive Plant

Benefitbee®







**YOU DESERVE THE BEST FROM BENEFITBEE**



 **Benefitbee**<sup>®</sup>

 [www.benefitbee.com](http://www.benefitbee.com)

 [info@benefitbee.com](mailto:info@benefitbee.com)

 +86 755 89697771

 +86 755 89697772

FL 5, Building 6, Liantang Industrial Zone, 48 Kangzheng Road, Danzhotou.

 Nanwan Street Office, Longgang District, Shenzhen, China 518114

No.2, Zone B, Hongfeng industrial park, Hongfeng town, Yangdong district.

Yangjiang City Guangdong province, China( Factory address )